

Victaulic® Differential Pressure Relief Valve

TA Series 782



1.0 PRODUCT DESCRIPTION

Available Sizes

- ½ – 1 ¼"/DN15 – DN32

Maximum Working Pressure

- 290 psi/2000 kPa

Setting Range

- 1.45 – 8.7 psi (10 – 60 kPa)

Operating Temperature Range

- -4°F to +248°F/-20°C to +120°C

Application

- Heating and cooling systems

Function

- Adjustable bypass pressure relief
- Shut-off

2.0 CERTIFICATION/LISTINGS

Not applicable – contact Victaulic with any questions.

ALWAYS REFER TO ANY NOTIFICATIONS AT THE END OF THIS DOCUMENT REGARDING PRODUCT INSTALLATION, MAINTENANCE OR SUPPORT.

System No.		Location	
Submitted By		Date	

Spec Section		Paragraph	
Approved		Date	

3.0 SPECIFICATIONS – MATERIAL

Valve Body: AMETAL® dezincification resistant (DZR) brass alloy

Bonnet: AMETAL®

Cone: AMETAL®

Stem: AMETAL®

Union Nuts: Brass

Sleeve: Brass

Cap: Brass

Gaskets: Graphite

Springs: Stainless steel

O-Rings: EPDM rubber

Guide Ring: PTFE

NOTE

- AMETAL® is the dezincification-resistant brass alloy of IMI TA.

4.0 DIMENSIONS

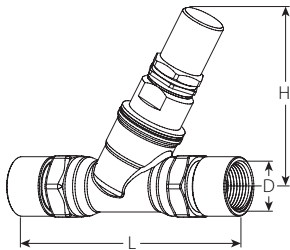

Size		Dimensions			Weight
Nominal inches DN	Actual Outside Diameter inches mm	D	L inches mm	H inches mm	Approx. (Each) lb kg
½ DN15	0.840 21.3	½ NPT	4.65 118	3.66 93	1.1 0.5
¾ DN20	1.050 26.9	¾ NPT	5.31 135	3.66 93	1.3 0.6
1 DN25	1.315 33.7	1 NPT	5.91 150	4.06 103	1.6 0.7
1¼ DN32	1.660 42.4	1 ¼ NPT	6.77 172	4.13 105	2.6 1.2

5.0 PERFORMANCE

Installation

Application example

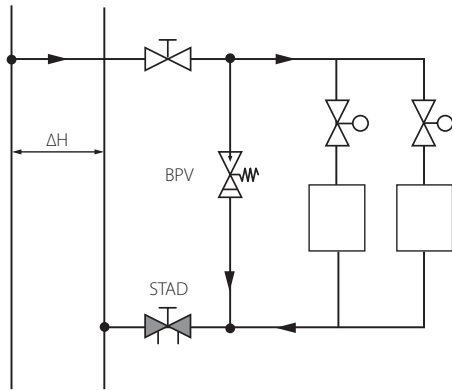

Installation of BPV

Install the BPV in the circuit before the balancing valve and between the supply and return pipe. The BPV is adjustable and opens at the preset differential pressure as control valves in the system are closed, making it possible to maintain desired pressure and flow in the distribution system. System temperature is also maintained and the pump is ensured a minimum flow.

5.1 PERFORMANCE

Setting

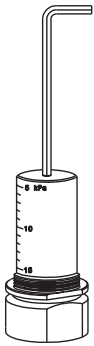

Use a 3 mm Allen key to adjust the BPV valve to operate at the required differential pressure.

5.2 PERFORMANCE





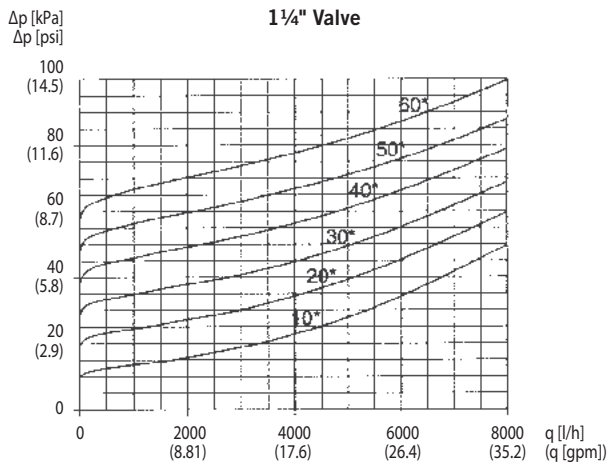
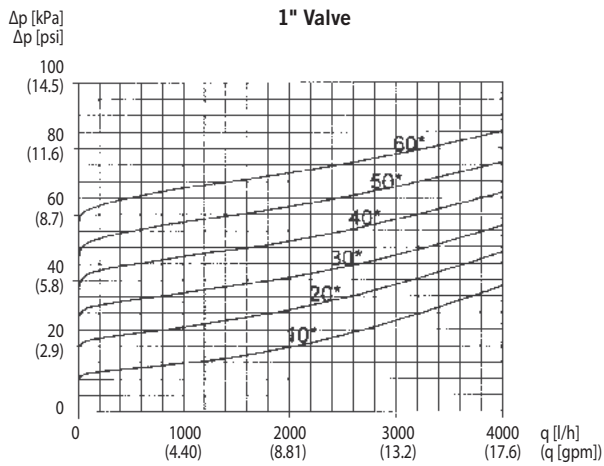
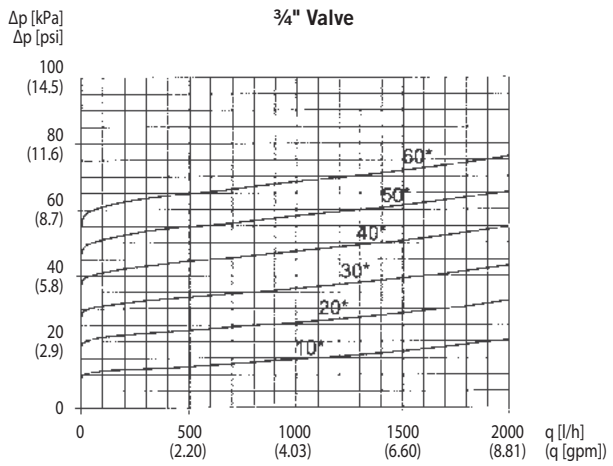
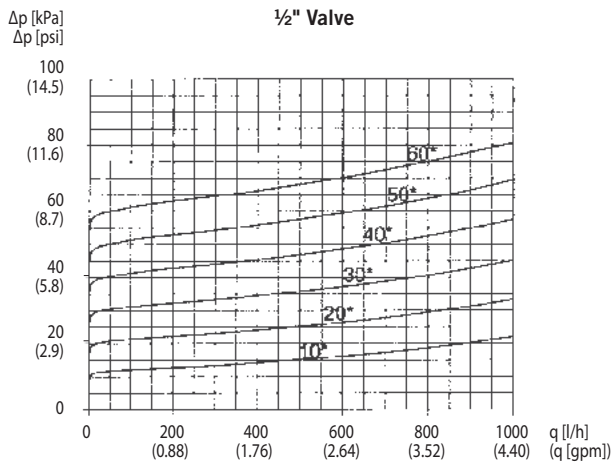

Valve Characteristics

Adjust the BPV valve to the required differential pressure 10-60 kPa (1.45-8.7 psi). The valve characteristics will be as shown in the diagrams below.



6.0 NOTIFICATIONS

⚠ WARNING



- Read and understand all instructions before attempting to install, remove, adjust, or maintain any Victaulic piping products.
- Always verify that the piping system has been completely depressurized and drained immediately prior to installation, removal, adjustment, or maintenance of any Victaulic products.
- Wear safety glasses, hardhat, and foot protection.

Failure to follow these instructions could result in death or serious personal injury and property damage.

7.0 REFERENCE MATERIALS

- [08.16: Victaulic Balancing Valves TA Series 786/787H/788/789 and Series 78KH](#)
- [08.30: Victaulic KOIL-KIT Coil Pack](#)
- [08.34: Victaulic Automatic Balancing Valves – Series 76T, 76B, 76K, 76V & 76G](#)
- [08.37: Victaulic Compact Pressure Independent Balancing and Control Valve \(Compact P\) – TA Series 7CP](#)
- [08.38: Victaulic TBV Terminal Balancing and Control Valves – Series TC & Series TCM](#)
- [08.46: Victaulic Differential pressure Controller – TA Series 7PR](#)
- [08.50: Victaulic Balancing Valve – TA Series 78BL](#)
- [08.53: Victaulic Combined Balancing and Control Valves – TA Series 7FP](#)
- [08.55: Victaulic Pressure Independent Balancing and Modulating Control Valve – TA Series 7MP](#)

User Responsibility for Product Selection and Suitability

Each user bears final responsibility for making a determination as to the suitability of Victaulic products for a particular end-use application, in accordance with industry standards and project specifications, as well as Victaulic performance, maintenance, safety, and warning instructions. Nothing in this or any other document, nor any verbal recommendation, advice, or opinion from any Victaulic employee, shall be deemed to alter, vary, supersede, or waive any provision of Victaulic Company's standard conditions of sale, installation guide, or this disclaimer.

Intellectual Property Rights

No statement contained herein concerning a possible or suggested use of any material, product, service, or design is intended, or should be construed, to grant any license under any patent or other intellectual property right of Victaulic or any of its subsidiaries or affiliates covering such use or design, or as a recommendation for the use of such material, product, service, or design in the infringement of any patent or other intellectual property right. The terms "Patented" or "Patent Pending" refer to design or utility patents or patent applications for articles and/or methods of use in the United States and/or other countries.

Note

This product shall be manufactured by Victaulic or to Victaulic specifications. All products to be installed in accordance with current Victaulic installation/assembly instructions. Victaulic reserves the right to change product specifications, designs and standard equipment without notice and without incurring obligations.

Installation

Reference should always be made to the Victaulic installation handbook or installation instructions of the product you are installing. Handbooks are included with each shipment of Victaulic products, providing complete installation and assembly data, and are available in PDF format on our website at www.victaulic.com.

Warranty

Refer to the Warranty section of the current Price List or contact Victaulic for details.

Trademarks

Victaulic and all other Victaulic marks are the trademarks or registered trademarks of Victaulic Company, and/or its affiliated entities, in the U.S. and/or other countries.