

Victaulic® Suction Vibration Isolation Pump Drop Series 331 – Hong Kong Only



1.0 PRODUCT DESCRIPTION

Available Sizes

- 3 – 12"/DN80 – DN300

Maximum Working Pressure

- Rated to the working pressure of the PN10/PN16 flange connection.

Temperature Range

- –30°F to +230°F/–34°C to +110°C

Application

- This Suction Vibration Isolation Pump Drop connects the water flow intake to the pump in the mechanical room.
- Provides noise reduction, expansion, contraction and deflection.

ALWAYS REFER TO ANY NOTIFICATIONS AT THE END OF THIS DOCUMENT REGARDING PRODUCT INSTALLATION, MAINTENANCE OR SUPPORT.

System No.		Location	
Submitted By		Date	

Spec Section		Paragraph	
Approved		Date	

1.0 PRODUCT DESCRIPTION (CONTINUED)

Vibration Attenuation Performance

- The following charts show the relative **vibration attenuation characteristics** of the Series 331 Suction Vibration Isolation Pump Drop compared to double sphere rubber connectors and stainless steel braided pump connectors, respectively, for typical HVAC pump speeds.
- For all sizes shown, the vibration attenuation provided by the Series 331 exceeds the vibration attenuation characteristics of the other products tested, for typical HVAC pump speeds.

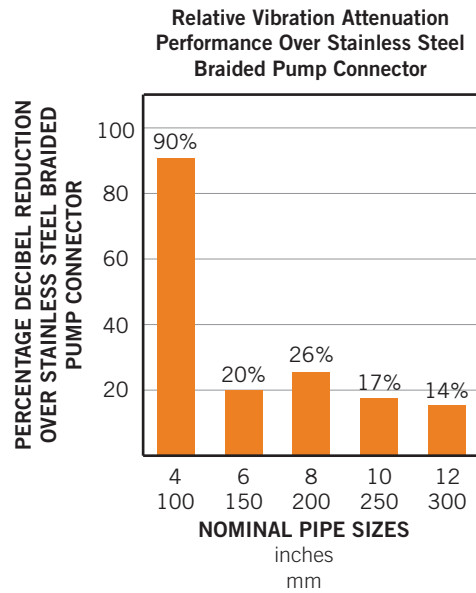
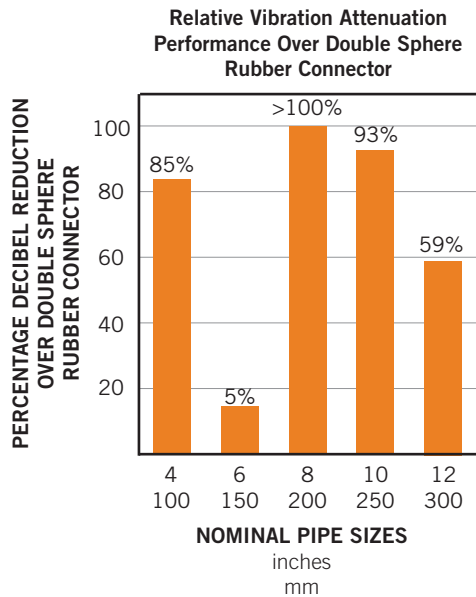

- Additionally, the Series 331 provides **linear movement and angular deflection capabilities**, along with the ability to **accommodate piping misalignment**, which should reduce stresses at pump or equipment connections.
- The use of either cut grooved or roll grooved pipe offers the same vibration attenuation characteristics.

NOTE

- For more information, please refer to [publication 26.04](#): Victaulic Couplings Vibration Attenuation Characteristics.

2.0 CERTIFICATION/LISTINGS

Product designed and manufactured under the Victaulic Quality Management System, as certified by LPCB in accordance with ISO-9001:2008.

3.0 SPECIFICATIONS – MATERIAL

- Standard weight carbon steel conforming to ASTM A53 Grade B or equal.
- Victaulic Original Groove System (OGS).
- Standard coupling coating: Orange enamel.
- Pipe spool coating: (specify choice)
 - Standard: Orange enamel.
 - Optional: Hot dipped galvanized.
- Gaskets are EPDM.
- Bolts/Nuts: Carbon steel oval neck track bolts meeting the mechanical property requirements of ASTM A449. Carbon steel heavy hex nuts meeting the mechanical property requirements of ASTM A563 Grade B. Track bolts and heavy hex nuts are zinc electroplated per ASTM B633 ZN/FE5, finish Type III (imperial) or Type II (metric).

Ductile iron butterfly valve: Body, end face, and seal retainer conforming to ASTM A536, Grade 65-45-12 with body black alkyd enamel coating.

Disc: Ductile iron conforming to ASTM A536, Grade 65-45-12, with electroless nickel coating conforming to ASTM B733.

Seat: EPDM.

Stems: 416 stainless steel conforming to ASTM A582.

Bearings: Fiberglass or 316 stainless steel with TFE lining.

Stem Seals: Furnished in same materials as seat.

Stem Retaining Ring: Carbon steel.

Lever Handle: Sizes 3 – 6"/DN80 – DN150: 10 Position (with Lever Lock) - Zinc plated carbon steel handle with zinc plated carbon steel latch plate and zinc plated carbon steel fasteners - Infinitely variable, padlockable and includes memory stop. Optionally available with tamper-resistant hardware.

Gear Operator: Sizes 8 – 12"/DN200 – DN300 – Provided with handwheel.

Ductile iron suction diffuser: Body, coupling and end cap conforming to ASTM A395, with orange enamel coating.

Diffuser: Type 304 stainless steel, frame and perforated sheet with $\frac{5}{32}$ "/4 mm diameter holes.

Start-Up Pre-Filter: 20 mesh stainless steel, Type 304.

Bolts/Nuts: Carbon steel oval neck track bolts meeting the mechanical property requirements of ASTM A449. Carbon steel heavy hex nuts meeting the mechanical property requirements of ASTM A563 Grade B. Track bolts and heavy hex nuts are zinc electroplated per ASTM B633 ZN/FE5, finish Type III (imperial) or Type II (metric).

Pressure Gauge Connection: $\frac{1}{2}$ "/15 mm BSPT.

4.0 DIMENSIONS

Series 331 Suction Vibration Isolation Pump Drop

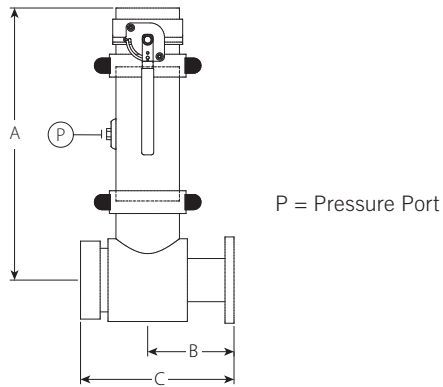

Size		Dimensions			Weight	
Actual Outside Diameter		A	B	C	Approx. (Each)	
mm	inches	mm	mm	mm	kg ¹	
inches		inches	inches	inches	lb	
88.9 3.500	x	60.3	551	160	279	21.3
		2.375	21.69	6.30	10.98	47.0
		76.1	551	160	279	30.3
		3.000	21.69	6.30	10.98	66.8
		88.9	551	160	279	24.8
3.500		21.69	6.30	10.98	54.7	
114.3 4.500	x	76.1	650	188	330	30.3
		3.000	25.59	7.40	12.99	66.8
		88.9	650	188	330	31.2
		3.500	25.59	7.40	12.99	68.8
		114.3	650	188	330	32.5
4.500		25.59	7.40	12.99	71.7	
139.7 5.500	x	88.9	708	213	381	47.5
		3.500	27.87	8.39	15.00	104.7
		114.3	708	213	381	49.0
		4.500	27.87	8.39	15.00	108.0
		139.7	708	213	381	50.3
5.500		27.87	8.39	15.00	110.9	
165.1 6.500	x	114.3	720	229	406	58.1
		4.500	28.35	9.02	15.98	128.1
		139.7	720	229	406	59.6
		5.500	28.35	9.02	15.98	131.4
		165.1	720	229	406	61.0
6.500		28.35	9.02	15.98	134.5	
219.1 8.625	x	139.7	737	259	483	94.5
		5.500	29.02	10.20	19.02	208.3
		165.1	737	259	483	96.1
		6.500	29.02	10.20	19.02	211.9
		219.1	737	259	483	100.0
8.625		29.02	10.20	19.02	220.5	

¹ Estimated weight using standard weight pipe.

4.0 DIMENSIONS (CONTINUED)

Series 331 Suction Vibration Isolation Pump Drop

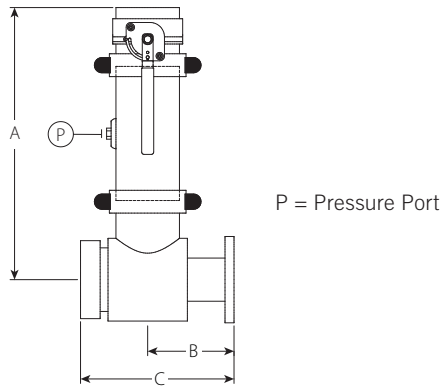

Size		Dimensions			Weight
Actual Outside Diameter		A	B	C	Approx. (Each)
mm inches		mm inches	mm inches	mm inches	kg ¹ lb
273.0 x 10.750	165.1	858	315	584	159.0
	6.500	33.78	12.40	22.99	350.5
	219.1	858	315	584	163.2
	8.625	33.78	12.40	22.99	360.0
273.0 x 10.750	273.0	858	315	584	168.7
	10.750	33.78	12.40	22.99	371.9
	323.9 x 12.750	915	392	686	211.4
	8.625	36.02	15.43	27.01	466.1
323.9 x 12.750	273.0	915	392	686	218.1
	10.750	36.02	15.43	27.01	480.8
	323.9	915	392	686	224.0
	12.750	36.02	15.43	27.01	493.8

¹ Estimated weight using standard weight pipe.

5.0 COMPONENT PERFORMANCE

Butterfly Valve Flow Characteristics

C_v/K_v values for flow of water at +60°F/+16°C with various disc positions are shown in the table below.

Formulas for C_v/K_v values:

$$\Delta P = \frac{Q^2}{C_v^2}$$

$$Q = C_v \times \sqrt{\Delta P}$$

Where:

Q = Flow (GPM)

ΔP = Pressure Drop (psi)

C_v = Flow Coefficient

$$\Delta P = \frac{Q^2}{K_v^2}$$

$$Q = K_v \times \sqrt{\Delta P}$$

Where:

Q = Flow (m³/hr)

ΔP = Pressure Drop (Bar)





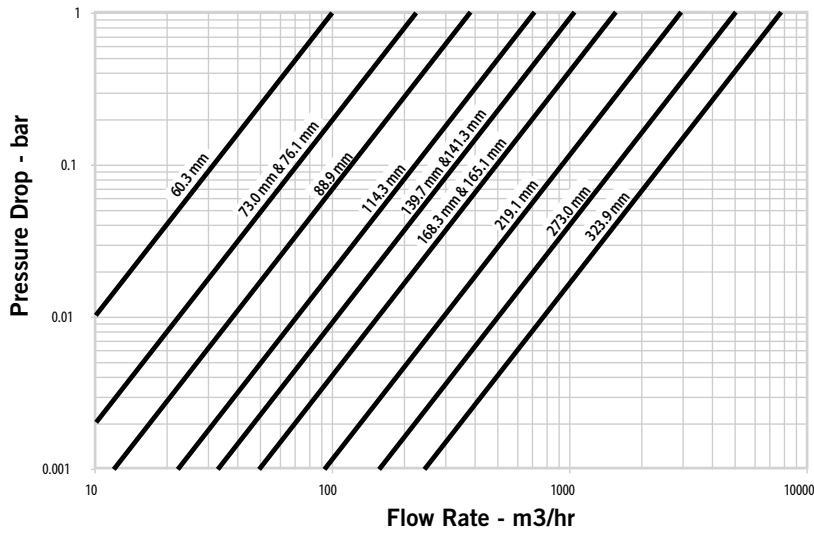
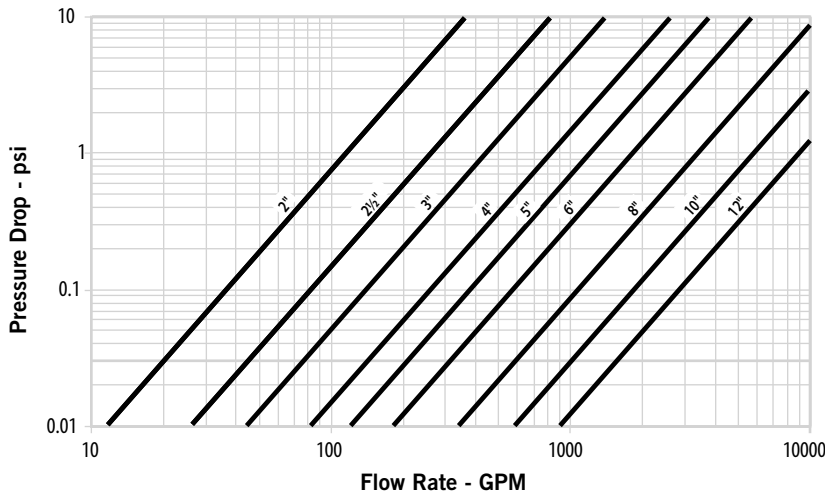

K_v = Flow Coefficient

Size		C _v K _v
Nominal inches DN	Actual Outside Diameter inches mm	
3 DN80	3.500 88.90	440 379
4 DN100	4.500 114.30	820 707
5 DN125	5.563 141.30	1200 1034
6 DN150	6.625 168.30	1800 1552
8 DN200	8.625 219.10	3400 2931
10 DN250	10.750 273.00	5800 5000
12 DN300	12.750 323.90	9000 7758

5.0 COMPONENT PERFORMANCE (CONTINUED)

Butterfly Valve Flow Characteristics



Size		Flow Coefficients					
Nominal inches DN	Actual Outside Diameter inches mm	Disc Position (Degrees Open)					
		90	70	60	50	40	30
		 C _v K _v	 C _v K _v	 C _v K _v	 C _v K _v	 C _v K _v	 C _v K _v
3 DN80	3.500 88.9	440 379	230 198	140 121	90 78	50 43	26 22
4 DN100	4.500 114.3	820 707	430 371	250 216	160 138	100 86	50 43
5 DN125	5.563 141.3	1200 1034	620 534	370 319	240 207	140 121	70 60
6 DN150	6.625 168.3	1800 1552	940 8190	560 483	360 310	220 190	110 95
8 DN200	8.625 219.1	3400 2931	1770 1526	1050 905	670 578	410 353	200 172
10 DN250	10.750 273.0	5800 5000	3020 2603	1800 1552	1150 991	700 603	350 302
12 DN300	12.750 323.9	9000 7758	4680 4034	2790 2405	1780 1534	1080 931	540 465

5.1 COMPONENT PERFORMANCE

Suction Diffuser Flow Characteristics

Formulas for C_v/K_v values:

$$\Delta P = \frac{Q^2}{C_v^2}$$

$$Q = C_v \times \sqrt{\Delta P}$$

Where:

Q = Flow (GPM)

ΔP = Pressure Drop (psi)

C_v = Flow Coefficient

$$\Delta P = \frac{Q^2}{K_v^2}$$

$$Q = K_v \times \sqrt{\Delta P}$$

Where:

Q = Flow (m³/hr)

ΔP = Pressure Drop (Bar)

K_v = Flow Coefficient

Size		Actual Outside Diameter		Flow Data	C_v K_v
Nominal inches DN		inches mm			
3 DN80	x 2 DN50	3.500 88.9	x 2.375 60.3	A	79 68
	2½		2.875 73.0	A	79 68
	3 DN80		3.500 88.9	B	90 79
4 DN100	x 2½	4.500 114.3	x 2.875 73.0	D	144 125
	3 DN80		3.500 88.9	D	144 125
	4 DN100		4.500 114.3	E	161 139
5	x 2½	5.563 141.3	x 2.875 73.0	F	206 178
	3 DN80		3.500 88.9	F	206 178
	4 DN100		4.500 114.3	G	232 200
	5		5.563 141.3	H	251 217
6 DN150	x 3 DN80	6.625 168.3	x 3.500 88.9	I	295 255
	4 DN100		4.500 114.3	I	295 255
	5		5.563 141.3	J	361 312
	6 DN150		6.625 168.3	J	361 312
8 DN200	x 4 DN100	8.625 219.1	x 4.500 114.3	L	509 440
	5		5.563 141.3	L	509 440
	6 DN150		6.625 168.3	M	575 497
	8 DN200		8.625 219.1	N	642 555
10 DN250	x 6 DN150	10.750 273.0	x 6.625 168.3	O	821 710
	8 DN200		8.625 219.1	P	917 793
	10 DN250		10.750 273.0	Q	1003 867
12 DN300	x 8 DN200	12.750 323.9	x 8.625 219.1	R	1352 1170
	10 DN250		10.750 273.0	R	352 1170
	12 DN300		12.750 323.9	S	1445 1249

5.1 COMPONENT PERFORMANCE (CONTINUED)

Suction Diffuser Flow Characteristics

Formulas for C_v/K_v values:

$$\Delta P = \frac{Q^2}{C_v^2}$$

$$Q = C_v \times \sqrt{\Delta P}$$

Where:

Q = Flow (GPM)

ΔP = Pressure Drop (psi)

C_v = Flow Coefficient

$$\Delta P = \frac{Q^2}{K_v^2}$$

$$Q = K_v \times \sqrt{\Delta P}$$

Where:

Q = Flow (m³/hr)

ΔP = Pressure Drop (Bar)

K_v = Flow Coefficient

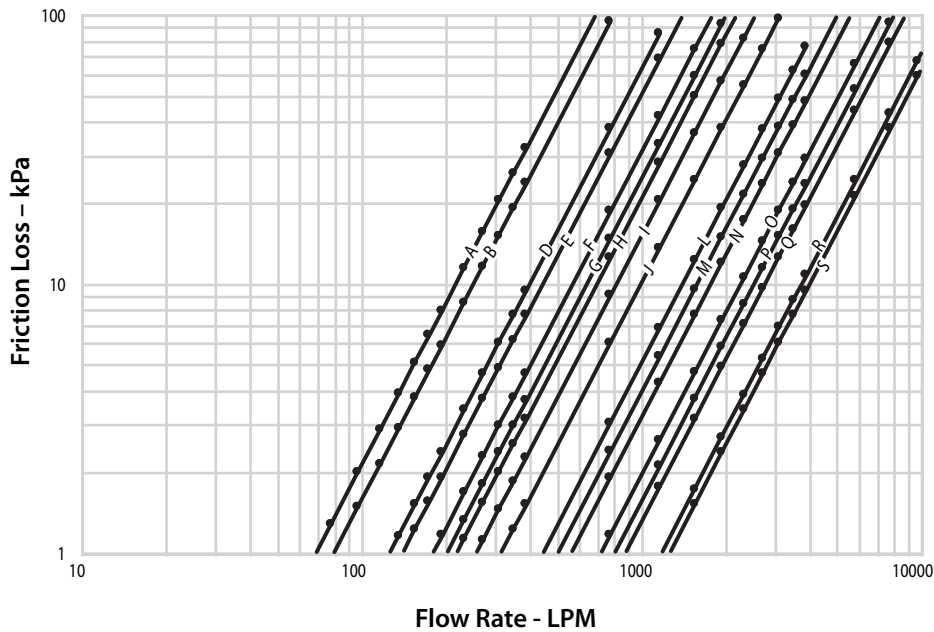
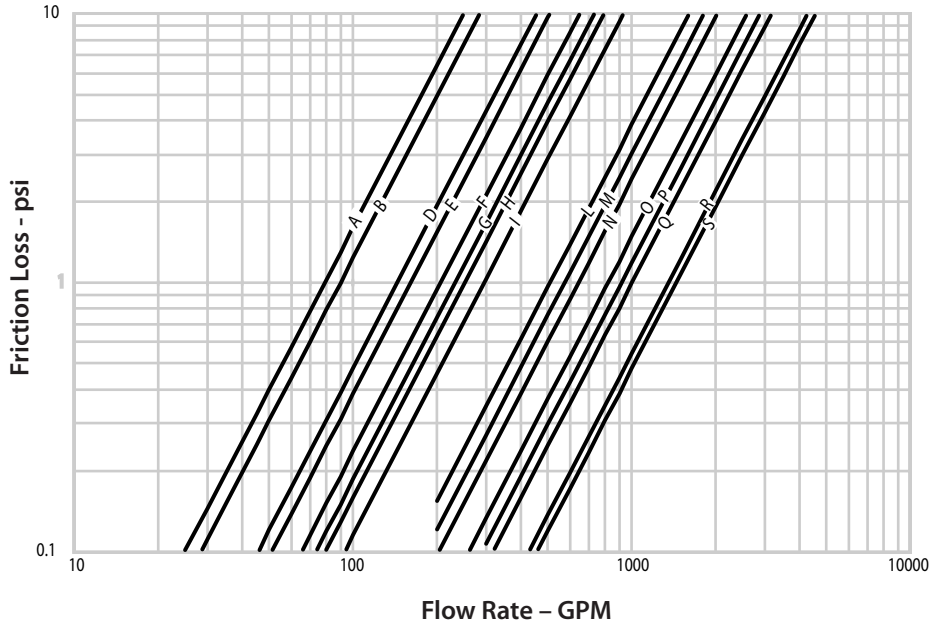

6.0 NOTIFICATIONS

WARNING



- Read and understand all instructions before attempting to install, remove, adjust, or maintain any Victaulic piping products.
- Depressurize and drain the piping system before attempting to install, remove, adjust, or maintain any Victaulic piping products.
- Wear safety glasses, hardhat, and foot protection.
- A Victaulic flexible coupling (not included) must also be installed in the piping above the Series 331 Vibration Isolation Pump Drop when using a vertical configuration with no reduction in pipe size.

Failure to follow these instructions could result in death or serious personal injury and property damage.

7.0 REFERENCE MATERIALS

[05.01: Victaulic Seal Selection Guide](#)

[06.15: Victaulic Pressure Ratings and End Loads for Victaulic Couplings on Steel Pipe](#)

[26.01: Victaulic Design Data](#)

[26.04: Victaulic Vibration Couplings Vibration Attenuation Characteristics](#)

[29.01: Victaulic Terms and Conditions/Warranty](#)

[I-100: Victaulic Field Installation Handbook](#)

[I-177N: Installation Instructions for QuickVic™ Flexible Coupling - Style 177N](#)

[I-731D IW731D: Installation & Servicing Instructions for Suction Diffuser - Series 731-D](#)

User Responsibility for Product Selection and Suitability

Each user bears final responsibility for making a determination as to the suitability of Victaulic products for a particular end-use application, in accordance with industry standards and project specifications, and the applicable building codes and related regulations as well as Victaulic performance, maintenance, safety, and warning instructions. Nothing in this or any other document, nor any verbal recommendation, advice, or opinion from any Victaulic employee, shall be deemed to alter, vary, supersede, or waive any provision of Victaulic Company's standard conditions of sale, installation guide, or this disclaimer.

Intellectual Property Rights

No statement contained herein concerning a possible or suggested use of any material, product, service, or design is intended, or should be construed, to grant any license under any patent or other intellectual property right of Victaulic or any of its subsidiaries or affiliates covering such use or design, or as a recommendation for the use of such material, product, service, or design in the infringement of any patent or other intellectual property right. The terms "Patented" or "Patent Pending" refer to design or utility patents or patent applications for articles and/or methods of use in the United States and/or other countries.

Note

This product shall be manufactured by Victaulic or to Victaulic specifications. All products to be installed in accordance with current Victaulic installation/assembly instructions. Victaulic reserves the right to change product specifications, designs and standard equipment without notice and without incurring obligations.

Installation

Reference should always be made to the Victaulic installation handbook or installation instructions of the product you are installing. Handbooks are included with each shipment of Victaulic products, providing complete installation and assembly data, and are available in PDF format on our website at www.victaulic.com.

Warranty

Refer to the Warranty section of the current Price List or contact Victaulic for details.

Trademarks

Victaulic and all other Victaulic marks are the trademarks or registered trademarks of Victaulic Company, and/or its affiliated entities, in the U.S. and/or other countries.