

# Victaulic® Flange Adapter for HDPE-to-Flanged Pipe Style 904



## 1.0 PRODUCT DESCRIPTION

### Available Sizes

- 3 – 8" IPS high-density polyethylene (HDPE) to 3 – 8" IPS ANSI Class 150 Flange

### Pipe Material

- HDPE pipe conforming to ASTM D3035 and ASTM F714 (SDR 7 – 21)

### Maximum Working Pressure

- Meets or exceeds the pressure rating of the pipe in accordance with the specifications and limitations in section 5.0 of this document

### Operating Temperature

- Dependent upon pipe manufacturer rating and gasket selection
- Reference section 3.0 for gasket performance options
- Consult pipe manufacturer for pipe material performance limitations

### Function

- Provides a single transition from plain end HDPE pipe to flanged piping system components
- Utilizes patented Installation-Ready™ technology to eliminate loose parts

### Pipe Preparation

- For use on plain end HDPE pipe

## 2.0 CERTIFICATION/LISTINGS

Product designed and manufactured under Victaulic's Quality Management System, as certified by LPCB in accordance with ISO 9001:2008.

ALWAYS REFER TO ANY NOTIFICATIONS AT THE END OF THIS DOCUMENT REGARDING PRODUCT INSTALLATION, MAINTENANCE OR SUPPORT.

System No.		Location	
Submitted By		Date	

Spec Section		Paragraph	
Approved		Date	

### 3.0 SPECIFICATIONS – MATERIAL

**Housing:** Ductile iron conforming to ASTM A 536, Grade 65-45-12.

**Housing Coating: (specify choice)**

Standard: Orange enamel.

Optional: Fusion bonded epoxy, galvanized and other coatings are available. Contact Victaulic for details.

**Retaining Ring:** Type 316 stainless steel.

**HDPE Flange Stub Insert: (specify choice)**

**SDR 11**

Plastic Pipe Institute (PPI) listed high-density polyethylene (HDPE) PE100/PE4710.

**SDR 17**

Plastic Pipe Institute (PPI) listed high-density polyethylene (HDPE) PE100/PE4710.

**Coupling Gasket: (specify choice<sup>1</sup>)**

**Grade “T” Nitrile**

Nitrile (Orange stripe color code). Temperature range -20°F to +180°F/-29°C to +82°C. May be specified for petroleum products, hydrocarbons, air with oil vapors, vegetable and mineral oils within the specified temperature range, not compatible for hot dry air over +140°F/+60°C and water over +150°F/+66°C. NOT COMPATIBLE FOR USE WITH HOT WATER SERVICES OR STEAM SERVICES.

**Grade “E” EPDM**

EPDM (Green stripe color code). Temperature range -30°F to +230°F/-34°C to +110°C. May be specified for cold and hot water service within the specified temperature range plus a variety of dilute acids, oil-free air and many chemical services. UL Classified in accordance with ANSI/NSF 61 for cold +73°F/+23°C and hot +180°F/+82°C potable water service and ANSI/NSF 372. NOT COMPATIBLE FOR PETROLEUM SERVICES OR STEAM SERVICES.

**Grade “O” Fluoroelastomer**

Fluoroelastomer (Blue stripe color code). Temperature range +20°F to +300°F/-34°C to +110°C. May be specified for many oxidizing acids, petroleum oils, halogenated hydrocarbons, lubricants, hydraulic fluids, organic liquids and air with hydrocarbons. NOT COMPATIBLE FOR USE WITH HOT WATER SERVICES OR STEAM SERVICES.

<sup>1</sup> Services listed are General Service Guidelines only. It should be noted that there are services for which these gaskets are not compatible. Reference should always be made to the latest [Victaulic Gasket Selection Guide](#) for specific gasket service guidelines and for a listing of services which are not compatible.

**NOTE**

- The maximum temperature ratings shown exceed the temperature ratings for HDPE pipe. Consult individual pipe manufacturers for specific temperature limits.

**Hardware:**

**Draw Bolts/Nuts: (specify choice<sup>2</sup>)**

Standard: Carbon steel oval neck track bolts meeting the mechanical property requirements of ASTM A449 (imperial) and ISO 898-1 Class 9.8 (M10-M16) Class 8.8 (M20 and greater). Carbon steel hex nuts meeting the mechanical property requirements of ASTM A563 Grade B (imperial - heavy hex nuts) and ASTM A563M Class 9 (metric - hex nuts). Track bolts and hex nuts are zinc electroplated per ASTM B633 ZN/FE5, finish Type III (imperial) or Type II (metric), with fluoropolymer top coat. Hardened steel washers conforming to ASTM F436 Type 3 (weathering steel).

Optional<sup>2</sup>:

3 – 4": Stainless steel oval neck track bolts meeting the mechanical property requirements of ASTM F593, Group 2 (316 stainless steel), condition CW. Stainless steel heavy hex nuts meeting the mechanical property requirements of ASTM F594, Group 2 (316 stainless steel), condition CW, with galling reducing coating. Hardened steel washers conforming to ASTM F436 Type 3 (weathering steel).

6 – 8": Stainless steel oval neck track bolts meeting the mechanical property requirements of ASTM A193 Class 2, Grade B8M. Stainless steel heavy hex nuts meeting the mechanical property requirements of ASTM A194 Grade 8M Heavy Hex, with galling reducing coating. Hardened steel washers conforming to ASTM F436 Type 3 (weathering steel).

<sup>2</sup> Optional bolts/nuts available in imperial size only

## 4.0 DIMENSIONS

### Style 904 – IPS Standard

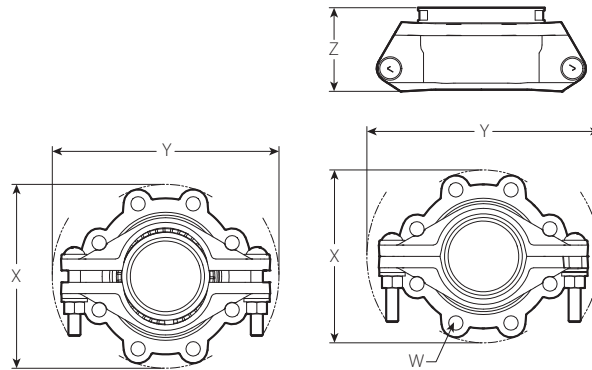

Style 904 Pre-Assembled

Style 904 Assembled

IPS Size		Draw Bolt/Nut		Flange Bolt/Nut		Dimensions						Weight
Nominal inches	Actual Outside Diameter inches mm	Qty.	Size inches mm	Qty.	Size inches mm	Pre-Assembled			Assembled			Approximate (Each) lb kg
						X inches mm	Y inches mm	W inches mm	X inches mm	Y inches mm	Z inches mm	
3	3.500 88.9	2	$\frac{5}{8}$ x 3 $\frac{1}{2}$ M16 x 89	4	$\frac{5}{8}$ M16	8.13 207	8.88 226	6.00 152	7.63 194	8.88 226	3.88 99	10.2 4.6
4	4.500 114.3	2	$\frac{5}{8}$ x 4 $\frac{1}{4}$ M16 x 108	8	$\frac{5}{8}$ M16	9.75 248	11.38 289	7.50 191	9.13 232	11.25 286	4.50 114	16.1 7.3
6	6.625 168.3	2	$\frac{3}{4}$ x 4 $\frac{1}{4}$ M20 x 108	8	$\frac{3}{4}$ M20	11.88 302	14.25 362	9.50 241	11.13 283	14.13 359	4.88 124	23.6 10.7
8	8.625 219.1	2	$\frac{3}{4}$ x 6 $\frac{1}{4}$ M20 x 159	8	$\frac{3}{4}$ M20	14.50 368	16.75 425	11.75 298	13.63 346	17.25 438	5.38 137	31.9 14.5

## 5.0 PERFORMANCE

### Style 904 – IPS Standard

Pressure Rating: joints made with Style 904 flange adapter meet the pressure rating of the HDPE pipe.

IPS Size	PE4710 HDPE Pipe <sup>3</sup>					
	DR					
Nominal Size inches	7	9	11	13.5	17	21
	Pressure Rating					
	psi					
	kPa					
3 - 8	285* 1965*	250 1725	200 1380	160 1100	125 860	100 690

<sup>3</sup> HDPE pipe conforming to ASTM D3035 and F714 at 73°F/23°C. Reference plastic pipe manufacture data for derating factors at other temperatures.

\* Maximum allowable pressure for ANSI Class 150lb flange. Under no circumstances shall working pressure exceed 285 psi at any temperature. Elevated temperature derate estimates can assume 333 psi maximum working pressure for DR7 pipe at 73°F/23°C.

**NOTE**

- Victaulic coupling gaskets have been demonstrated to seal under full (29" of Hg/3.4 kPa [absolute]) vacuum requirements. Consult the specific HDPE pipe manufacturer for their recommended limitations regarding maximum vacuum as well as the effects of temperature and pipe ovality.

## 5.1 PERFORMANCE

### Style 904 – IPS Standard

Allowable Tensile Load (ATL): joints made with Style 904 flange adapter can sustain tensile loads noted below.

IPS Size	Allowable Tensile Load <sup>4</sup>					
	DR					
Nominal Size inches	7	9	11	13.5	17	21
	lb					
	N					
3	5146	4151	3473	2882	2327	1906
	22890	18463	15449	12821	10349	8478
4	8507	6861	5741	4765	3846	3151
	37839	30520	25539	21195	17108	14016
6	18437	14871	12444	10327	8336	6829
	82013	66151	55353	45938	37081	30377
8	31200	25200	21100	17500	14100	11574
	138784	112095	93857	77844	62720	51484

<sup>4</sup> Allowable tensile loads shown are for straight pulling for a maximum period of one half hour at ambient temperature (68°F/20°C).

## 5.2 PERFORMANCE





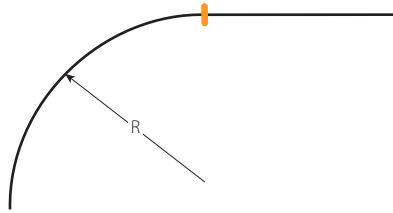

### Style 904 – IPS Standard

Bend Radius: joints made with Style 904 flange adapter can sustain a bending radius as recommended by the Plastic Pipe Institute (PPI) in the Handbook of PE Pipe (2nd ed, Chapter 7, Table 4).



IPS Size	Minimum Recommended Bend Radius					
	DR					
Nominal Size inches	7	9	11	13.5	17	21
	inches mm					
3	70	70	88	88	95	95
	1778	1778	2223	2223	2400	2400
4	90	90	113	113	122	122
	2286	2286	2858	2858	3086	3086
6	133	133	166	166	179	179
	3366	3366	4207	4207	4543	4543
8	173	173	216	216	233	233
	4382	4382	5477	5477	5915	5915

## 6.0 NOTIFICATIONS

 <b>WARNING</b>				
				
<ul style="list-style-type: none"> <li>• Read and understand all instructions before attempting to install, remove, adjust, or maintain any Victaulic piping products.</li> <li>• Depressurize and drain the piping system before attempting to install, remove, adjust, or maintain any Victaulic piping products.</li> <li>• Wear safety glasses, hardhat, and foot protection.</li> </ul> <p>Failure to follow these instructions may cause joint failure, resulting in death or serious personal injury and property damage.</p>				

---

## 7.0 REFERENCE MATERIALS

---

- [I-900: Victaulic HDPE Products Installation and Assembly Manual](#)
- [IT-904: Victaulic Style 904 Installation Tag](#)
- [05.01: Victaulic Gasket Selection Guide](#)
- [19.07: Victaulic Style 905 Coupling for Plain End HDPE](#)
- [19.09: Victaulic Style 908 Coupling for Double Grooved HDPE pipe](#)
- [19.10: Victaulic Style 907 Transition Coupling for HDPE-to-Steel](#)
- [19.11: Victaulic HDPE Plain End Fittings](#)
- [19.12: Victaulic Style 904 Flange Adapter for HDPE-to-Flanged Pipe](#)
- [29.01: Victaulic Terms and Conditions/Warranty](#)

---

### User Responsibility for Product Selection and Suitability

Each user bears final responsibility for making a determination as to the suitability of Victaulic products for a particular end-use application, in accordance with industry standards and project specifications, and the applicable building codes and related regulations as well as Victaulic performance, maintenance, safety, and warning instructions. Nothing in this or any other document, nor any verbal recommendation, advice, or opinion from any Victaulic employee, shall be deemed to alter, vary, supersede, or waive any provision of Victaulic Company's standard conditions of sale, installation guide, or this disclaimer.

### Intellectual Property Rights

No statement contained herein concerning a possible or suggested use of any material, product, service, or design is intended, or should be construed, to grant any license under any patent or other intellectual property right of Victaulic or any of its subsidiaries or affiliates covering such use or design, or as a recommendation for the use of such material, product, service, or design in the infringement of any patent or other intellectual property right. The terms "Patented" or "Patent Pending" refer to design or utility patents or patent applications for articles and/or methods of use in the United States and/or other countries.

### Note

This product shall be manufactured by Victaulic or to Victaulic specifications. All products to be installed in accordance with current Victaulic installation/assembly instructions. Victaulic reserves the right to change product specifications, designs and standard equipment without notice and without incurring obligations.

### Installation

Reference should always be made to the Victaulic installation handbook or installation instructions of the product you are installing. Handbooks are included with each shipment of Victaulic products, providing complete installation and assembly data, and are available in PDF format on our website at [www.victaulic.com](http://www.victaulic.com).

### Warranty

Refer to the Warranty section of the current Price List or contact Victaulic for details.

### Trademarks

*Victaulic* and all other Victaulic marks are the trademarks or registered trademarks of Victaulic Company, and/or its affiliated entities, in the U.S. and/or other countries.