

Victaulic® StrengThin™ 100 System

Series E431 Suction Diffuser for Stainless Steel Pipe



31.10



1.0 PRODUCT DESCRIPTION

Available Sizes

- DN65 x DN50 through DN300 x DN250

Pipe Material

- Designed exclusively for use on 1.4301/1.4307 (304/304L) or 1.4401/1.4404 (316/316L) stainless steel pipe per EN 10217-7

Pipe Preparation

- Exclusively for use with pipe which feature ends formed with the Victaulic StrengThin™ 100 groove profile (see section 7.0 for Reference Materials).

Pressure Class

- Rated to the working pressure of the mating flange up to a maximum of 16 bar/1600 kPa/ 232 psi.

Application

- Provides optimum flow conditions at the inlet side of the pump.
- Removable basket and fine mesh sleeve act as start-up strainer.
- Pressure port in the cap measures pressure downstream of the diffuser.
- Plug in the cap allows for easy draining of the system.

2.0 CERTIFICATION/LISTINGS

Product designed and manufactured under Victaulic's Quality Management System, as certified by LPCB in accordance with ISO-9001. Refer to section 3.0 for potable water certifications of specific gasket materials.

ALWAYS REFER TO ANY NOTIFICATIONS AT THE END OF THIS DOCUMENT REGARDING PRODUCT INSTALLATION, MAINTENANCE OR SUPPORT.

System No.		Location	
Submitted By		Date	

Spec Section		Paragraph	
Approved		Date	

victaulic.com

31.10 11392 Rev A Updated 04/2019 © 2019 Victaulic Company. All rights reserved.



3.0 SPECIFICATIONS – MATERIAL

Body, End Cap, Reducer and Flange: Type 304L or 316L stainless steel.

Coupling Housing: Ductile iron conforming to ASTM A536, Grade 65-45-12; EN 1563, Grade EN-GJS-450-10; and ISO 1083, Grade JS/450-10/S.

Housing Coating: Hot dipped galvanized.

Coupling Gasket:

Victaulic EPDM

EPDM (Green stripe color code). Temperature range -30°F to +230°F/-34°C to +110°C. UL classified in accordance with ANSI/NSF 61 for cold +73°F/+23°C and hot +180°F/+82°C potable water service. NOT COMPATIBLE FOR USE WITH PETROLEUM SERVICES OR STEAM SERVICES.

Diffuser: Type 304 stainless steel frame and perforated sheet with 5 mm (3/16") diameter holes (51% open area).

Start-Up Pre-Filter: Stainless steel or bronze, 16 mesh screen.

Bolts/Nuts: Carbon steel oval neck track bolts meeting the mechanical property requirements of ISO 898-1 Class 9.8 (M10-M16) Class 8.8 (M20 and greater). Carbon steel heavy hex nuts meeting the mechanical property requirements of ASTM A563M Class 9 (metric – hex nuts). Track bolts and heavy hex nuts are zinc electroplated per ASTM B633 ZN/FE5, finish Type III (metric).

4.0 DIMENSIONS

Series E431 Suction Diffuser

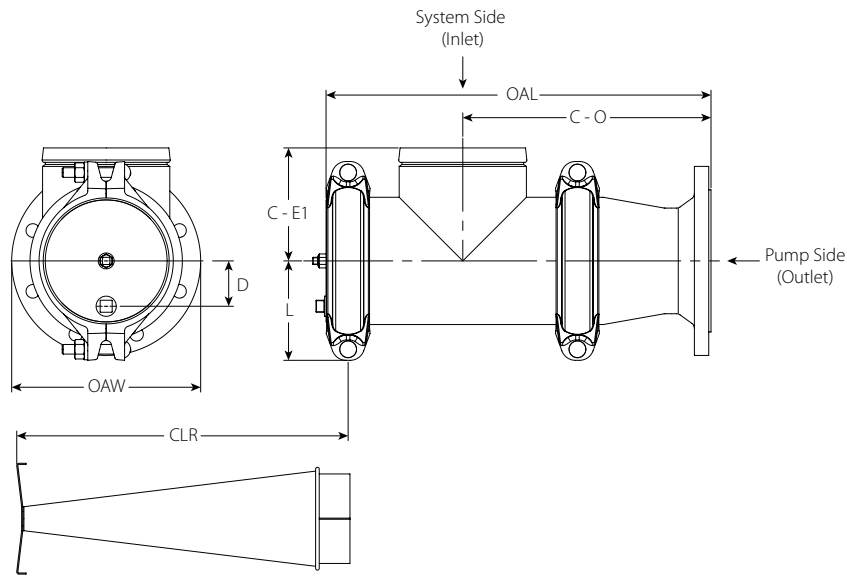

Size		Dimensions							Weight
Nominal inches DN		C-E1 inches mm	C-O inches mm	D inches mm	L inches mm	OAL inches mm	OAW inches mm	CLR inches mm	Approximate (Each) lb kg
DN65	2 x DN50	3.72 94	7.72 196	1.00 25	3.13 79	12.75 324	6.50 165	10.75 273	17.8 8.1
DN80	3 x DN65	4.00 102	8.47 215	1.00 25	3.25 83	13.75 349	7.28 185	11.75 298	19.7 8.9
DN100	4 x DN80	4.46 113	10.37 263	1.38 35	4.13 105	16.13 410	7.88 200	14.00 356	28.6 13.0
DN125	4 x DN100	5.25 133	11.00 279	1.88 48	4.63 117	17.63 448	8.66 220	15.50 394	38.6 17.5
DN150	6 x DN125	5.88 149	13.00 330	2.38 60	5.18 132	20.25 514	9.84 250	18.00 457	54.2 24.6
DN200	8 x DN150	7.73 196	14.47 368	3.25 83	6.50 165	23.88 607	11.22 285	21.50 546	93.4 42.4
DN250	10 x DN200	8.88 225	16.73 425	4.25 108	8.13 206	27.25 692	13.38 340	24.50 622	158.5 71.9
DN300	12 x DN250	10.37 263	18.85 479	5.38 137	9.13 232	31.00 787	15.94 405	28.00 711	230.4 104.5

5.0 PERFORMANCE

Series E431 Suction Diffuser Performance Data

C_v values for flow of water at +60°F (+16°C) are shown in the table below.

Formulas for C_v values:

$$\Delta P = \frac{Q^2}{C_v^2}$$

$$Q = C_v \times \sqrt{\Delta P}$$

Where:

Q = Flow (GPM)

ΔP = Pressure Drop (psi)

C_v = Flow Coefficient

$$\Delta P = \frac{Q^2}{K_v^2}$$

$$Q = K_v \times \sqrt{\Delta P}$$

Where:

Q = Flow (m³/hr)





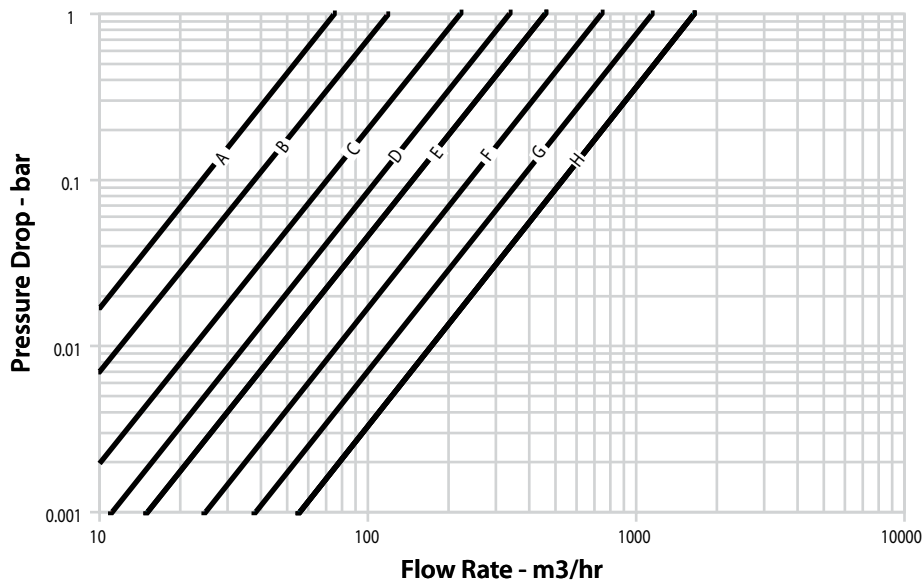

ΔP = Pressure Drop (Bar)

K_v = Flow Coefficient

Size		Flow Data	Values K _v C _v
Nominal inches	DN		
DN65	2 x DN50	A	73 85
DN80	3 x DN65	B	121 140
DN100	4 x DN80	C	225 260
DN125	6 x DN100	D	346 400
DN150	8 x DN125	E	476 550
DN200	10 x DN150	F	779 900
DN250	12 x DN200	G	1244 1400
DN300	12 x DN250	H	1730 2000



6.0 NOTIFICATIONS

⚠ WARNING					
					
<ul style="list-style-type: none">• Read and understand all instructions before attempting to install, remove, adjust, or maintain any Victaulic piping products.• Always verify that the piping system has been completely depressurized and drained immediately prior to installation, removal, adjustment, or maintenance of any Victaulic products.• Wear safety glasses, hardhat, and foot protection. <p>Failure to follow these instructions could result in death or serious personal injury and property damage.</p>					

7.0 REFERENCE MATERIALS

- [24.01: Victaulic Pipe Preparation Tools](#)
- [25.13: Victaulic StrengThin™ 100 Groove Specifications](#)
- [31.02: Victaulic StrengThin™ 100 System Style E497 Rigid Coupling for Stainless Steel Pipe](#)
- [31.04: Victaulic StrengThin™ 100 Fittings for Stainless Steel Pipe](#)
- [I-100: Victaulic Field Installation Handbook](#)
- [I-ENDCAP: Victaulic End Cap Installation Safety Instructions](#)

User Responsibility for Product Selection and Suitability

Each user bears final responsibility for making a determination as to the suitability of Victaulic products for a particular end-use application, in accordance with industry standards and project specifications, and the applicable building codes and related regulations as well as Victaulic performance, maintenance, safety, and warning instructions. Nothing in this or any other document, nor any verbal recommendation, advice, or opinion from any Victaulic employee, shall be deemed to alter, vary, supersede, or waive any provision of Victaulic Company's standard conditions of sale, installation guide, or this disclaimer.

Intellectual Property Rights

No statement contained herein concerning a possible or suggested use of any material, product, service, or design is intended, or should be construed, to grant any license under any patent or other intellectual property right of Victaulic or any of its subsidiaries or affiliates covering such use or design, or as a recommendation for the use of such material, product, service, or design in the infringement of any patent or other intellectual property right. The terms "Patented" or "Patent Pending" refer to design or utility patents or patent applications for articles and/or methods of use in the United States and/or other countries.

Note

This product shall be manufactured by Victaulic or to Victaulic specifications. All products to be installed in accordance with current Victaulic installation/assembly instructions. Victaulic reserves the right to change product specifications, designs and standard equipment without notice and without incurring obligations.

Installation

Reference should always be made to the Victaulic installation handbook or installation instructions of the product you are installing. Handbooks are included with each shipment of Victaulic products, providing complete installation and assembly data, and are available in PDF format on our website at www.victaulic.com.

Warranty

Refer to the Warranty section of the current Price List or contact Victaulic for details.

Trademarks

Victaulic and all other Victaulic marks are the trademarks or registered trademarks of Victaulic Company, and/or its affiliated entities, in the U.S. and/or other countries.