

# V33, K8.0

Standard Spray Dry Type Concealed Pendent

**V3303 STANDARD RESPONSE**  
**V3304 QUICK RESPONSE**

The Model V33 Series Dry Type Concealed Pendent Sprinkler with threaded cover assembly and 1/2" adjustment utilizes stainless steel internal components. The V33 Dry Sprinkler is used in special applications such as conditions where sediment or foreign materials might accumulate in ordinary drop nipples. The V33 provides an aesthetic sprinkler drop from an unheated location such as an attic space.

All that is seen at the ceiling is a 3 1/4" diameter ceiling plate, color finished to match the specifier's exact requirements. The V33 Dry Concealed Sprinkler incorporates a frangible glass bulb which is located above the ceiling and concealed from view by the ceiling plate. The plate is soldered to the sprinkler upper support assembly. Upon the application of sufficient heat, the plate falls to the floor exposing the pendent spray sprinkler. At the glass bulb's rated temperature, the sprinkler opens, releasing the bulb seat assembly, causing the inner tube assembly to move; allowing the spring assembly to pivot alongside the inner tube. Water then flows through the sprinkler and is distributed by the deflector in an approved discharge pattern.



SEE VICTAULIC PUBLICATION 10.01 FOR DETAILS



**PENDENT**  
**(V3303 AND V3304)**

**COVERAGE:**

For coverage area and sprinkler placement, refer to NFPA 13 standards.

**TECHNICAL SPECIFICATIONS:**

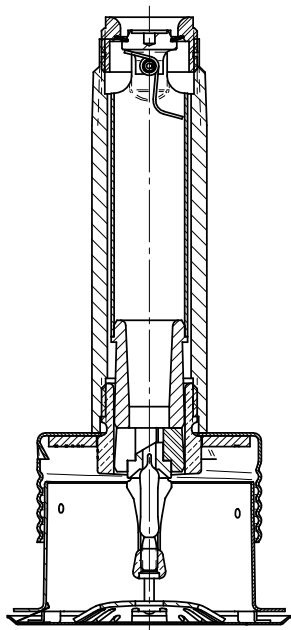

*Exaggerated for Clarity*

**Models:** V3303 and V3304  
**Style:** Concealed Pendent  
**Nominal Orifice Size:** 7/32" /14 mm  
**Orifice Insert:** Stainless steel per UNS S30300  
**K-Factor:** 8.0 Imp. (11,5 S.I.^)  
**Nominal Thread Size:** 1" NPT/33.7 mm  
**Max. Working Pressure:** 175 psi/1200 kPa  
**Factory Hydrostatic Test:**  
 100% @ 500 psi/3450 kPa  
**Min. Operating Pressure:** 7 psi/48 kPa  
**Temperature Rating:** See chart on page 2  
**Pins:** Stainless Steel Per UNS S30200

**Material Specifications**

**Deflector:** Bronze per UNS C22000  
**Bulb:** Glass with glycerin solution.  
**Bulb Nominal Diameter:**  
 • Standard: 5.0 mm  
 • Quick Response: 3.0 mm  
**Split Spacer:** Stainless steel per UNS S30300  
**Load Screw:** Brass per UNS C36000  
**Pip Cap:** Stainless steel per UNS S30300  
**Spring Seal Assembly:** Teflon\* coated Beryllium nickel alloy and stainless steel per UNS S30300  
**Frame:** Die cast brass  
**Outer Tube:** Galvanized steel pipe  
**Inner Tube:** Stainless steel per UNS S30400  
**Cup:** Cold rolled steel  
**Cover Plate Assembly:** Brass per UNS C26000  
**Torsion Spring:** SST Wire

**Accessories**

**Installation Wrench:**

- Model V33 Concealed Wrench fits all V33 Series frames.

**Sprinkler Finishes:**

- Chrome Plated
- Brass Plated
- White painted†
- Flat Black†
- Custom Painted†

For cabinets and other accessories refer to separate sheet.

^ For K-Factor when pressure is measured in Bar, multiply S.I. units by 10.0.

\* Teflon is a registered trademark of Dupont Co.

† These finishes require longer lead times. Contact Victaulic for details.

**JOB/OWNER**

System No. \_\_\_\_\_  
 Location \_\_\_\_\_

**CONTRACTOR**

Submitted By \_\_\_\_\_  
 Date \_\_\_\_\_

**ENGINEER**

Spec Sect \_\_\_\_\_ Para \_\_\_\_\_  
 Approved \_\_\_\_\_  
 Date \_\_\_\_\_

# V33, K8.0

Standard Spray Dry Type Concealed Pendent

**V3303 STANDARD RESPONSE**

**V3304 QUICK RESPONSE**

## APPROVALS/LISTINGS

Model	Orifice Size	Nominal K-Factor	Response	Deflector Type	Approved Temperature Ratings °F/°C ‡ *	
	Inches mm	Imperial S.I.^			UL	C-UL
V3304	7/32 14	8.0 11.5	Quick	Concealed Pendent	135, 155, 200 57, 68, 93	135, 155, 200 57, 68, 93
V3303	7/32 14	8.0 11.5	Standard	Concealed Pendent	135, 155, 200 57, 68, 93	135, 155, 200 57, 68, 93

‡ Listings and approval as of printing.

^ For K-Factor when pressure is measured in Bar, multiply S.I. units by 10.

\*Listed for up to ordinary hazards.

\*Listed for V3303 and V3304 up to 48" length.

# V33, K8.0

Standard Spray Dry Type Concealed Pendent

**V3303 STANDARD RESPONSE**

**V3304 QUICK RESPONSE**

**RATINGS**

All glass bulbs are rated for temperatures from -67°F/-55°C to those shown in table below.

Sprinkler Temperature Classification	SPRINKLER - V3303, V3304			COVER	
	Temperature – °F/°C		Glass Bulb Color	Cover Temperature – °F/°C	
	Nominal Temperature Rating	Maximum Ambient Temperature Allowed		Nominal Temperature Rating	Maximum Ambient Temperature Allowed
Ordinary	135/155	100	Orange/Red	135	100
	57/68	38		57	38
Intermediate	200	150	Green	165	150
	93	65		74	65

**ORDERING INFORMATION**

Please specify the following when ordering:

Sprinkler Model Number	
Style	
Temperature Rating	
K-Factor	
Quantity	
Sprinkler Finish	
*A* Dimension - Distance from face of fitting to the finished ceiling line.	





# V33, K8.0

Standard Spray Dry Type Concealed Pendent

V3303 STANDARD RESPONSE

V3304 QUICK RESPONSE



 <b>WARNING</b>	
    	<ul style="list-style-type: none"> <li>Always read and understand installation, care, and maintenance instructions, supplied with each box of sprinklers, before proceeding with installation of any sprinklers.</li> <li>Always wear safety glasses and foot protection.</li> <li>Depressurize and drain the piping system before attempting to install, remove, or adjust any Victaulic piping products.</li> <li>Installation rules, especially those governing obstruction, must be strictly followed.</li> <li>Painting, plating, or any re-coating of sprinklers (other than that supplied by Victaulic) is not allowed.</li> </ul> <p>Failure to follow these instructions could result in serious personal injury and/or property damage.</p> <p>The owner is responsible for maintaining the fire protection system and devices in proper operating condition. For minimum maintenance and inspection requirements, refer to the current National Fire Protection Association pamphlet that describes care and maintenance of sprinkler systems. In addition, the authority having jurisdiction may have additional maintenance, testing, and inspection requirements that must be followed.</p> <p>If you need additional copies of this publication, or if you have any questions about the safe installation of this product, contact Victaulic World Headquarters: P.O. Box 31, Easton, Pennsylvania 18044-0031 USA, Telephone: 001-610-559-3300.</p>

# V33, K8.0

Standard Spray Dry Type Concealed Pendent

V3303 STANDARD RESPONSE

V3304 QUICK RESPONSE

## DIMENSIONS

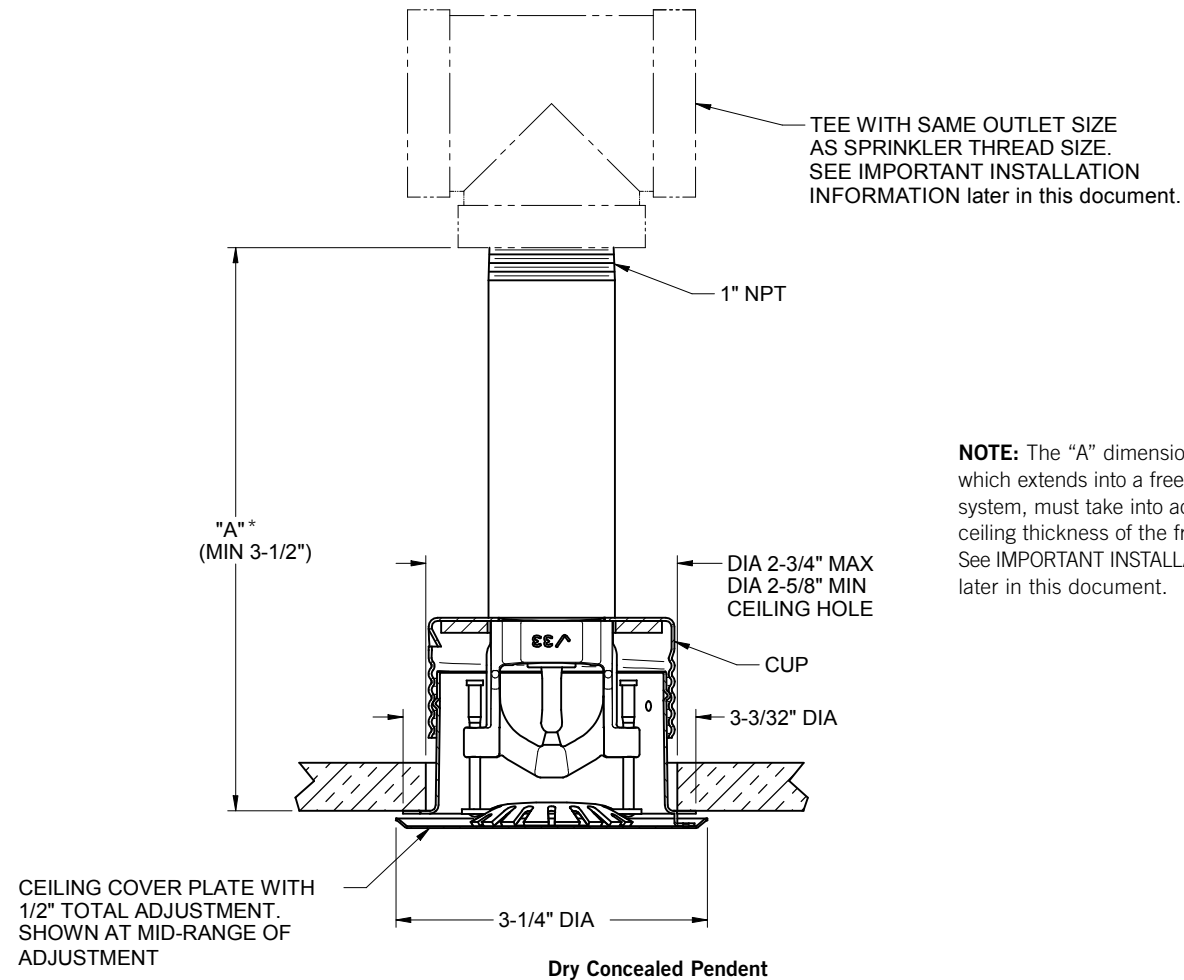

**NOTE:** The "A" dimension of a dry sprinkler, which extends into a freezer from a wet piping system, must take into account the wall or ceiling thickness of the freezer. See IMPORTANT INSTALLATION INFORMATION later in this document.

\*Victaulic standard spray dry type concealed pendent sprinklers are available in 1/8" incremental lengths. Please specify your required length to the nearest 1/8".

# V33, K8.0

Standard Spray Dry Type Concealed Pendent

**V3303 STANDARD RESPONSE**  
**V3304 QUICK RESPONSE**

**AVAILABLE WRENCH**

**Model V33 Concealed Wrench fits all V33 Series frames.**

**DISTRIBUTION PATTERNS**

**Models V3303, V3304**  
**K8.0 STANDARD & QUICK RESPONSE CONCEALED**  
**PENDENT DISTRIBUTION PATTERNS – TRAJECTORY**

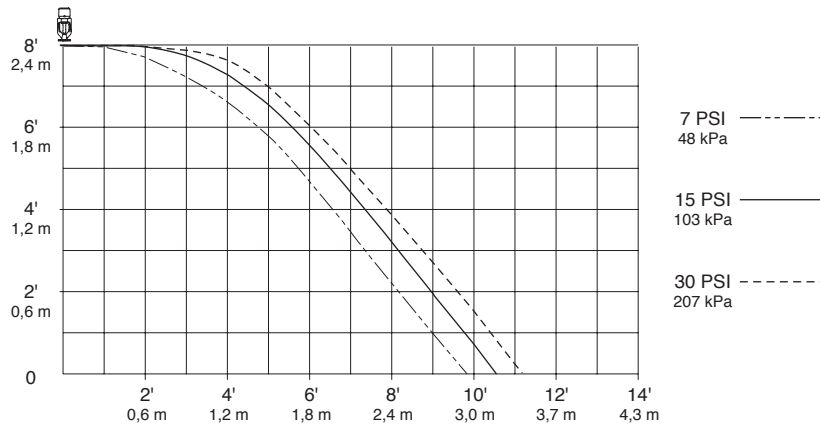

**NOTES:**

- 1 Data shown is approximate and can vary due to differences in installation.
- 2 These graphs illustrate approximate trajectories, floor-wetting, and wall-wetting patterns for these specific Victaulic FireLock automatic sprinklers. They are provided as information for guidance in avoiding obstructions to sprinklers and should not be used as minimum sprinkler spacing rules for installation. Refer to the appropriate NFPA National Fire Code or the authority having jurisdiction for specific information regarding obstructions, spacing limitations and area of coverage requirements. Failure to follow these guidelines could adversely affect the performance of the sprinkler and will void all Listings, Approvals and Warranties.
- 3 All patterns are symmetrical to the centerline of the waterway.

# V33, K8.0

Standard Spray Dry Type Concealed Pendent

V3303 STANDARD RESPONSE  
V3304 QUICK RESPONSE

## IMPORTANT INSTALLATION INFORMATION

For detailed installation instructions, see publication I-40

Victaulic Model V33 Series Dry Concealed sprinklers should be installed in accordance with NFPA 13. These sprinklers are to be installed using a pipe wrench applied to the outer tube. When this is not possible, the proper sprinkler wrench may be used with extreme care for lengths up to approximately 18". Excessive force may distort the frame thus destroying the unit.

Dry sprinklers MUST be installed only into the outlet of a cast or malleable iron tee.

DO NOT install dry sprinklers into any couplings or threaded elbows. In addition, DO NOT install dry sprinklers into any fitting that interferes with thread penetration.

**NOTE:** The end seal of the dry sprinkler MUST NOT bottom out in the fitting.

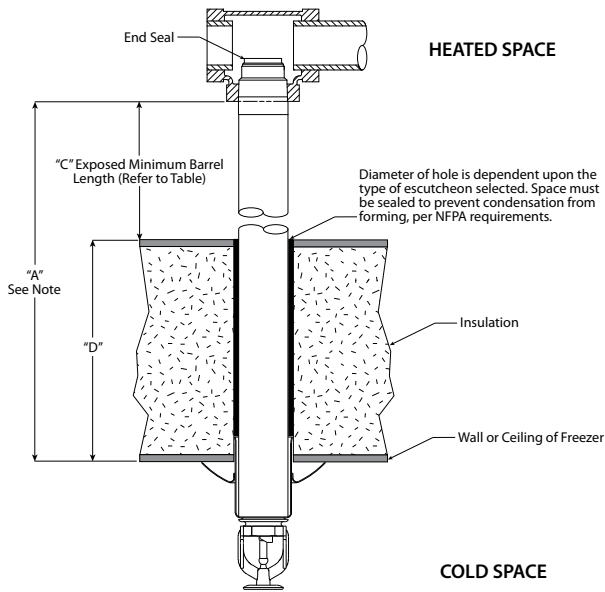

Exaggerated for Clarity

TYPICAL SLEEVE AND SKIRT CONFIGURATION FOR EXAMPLE ONLY

**NOTE:** The "A" dimension of a dry sprinkler, which extends into a freezer from a wet piping system, must take into account the wall or ceiling thickness of the freezer. The minimum length of the dry sprinkler should not be less than the lengths specified in the following table, plus the thickness of the freezer's wall or ceiling ("A" = "C" + "D").

Refer to the drawing for a representation of the "A" dimension. **DO NOT** attempt to modify dry sprinklers, since they are manufactured to this specific "A" dimension.

The following table is used when the ambient temperature is maintained between 40° F/4° C and 60° F/16° C around the wet piping system.

### Exposed Barrel Ambient Temperature (°F/°C)

Ambient Temperature Exposed to Discharge End of Sprinkler °F/°C	Exposed Minimum Barrel Length inches/mm		
	40°F/4°C	50°F/10°C	60°F/16°C
40	0	0	0
4	0	0	0
30	0	0	0
-1	0	0	0
20	4	0	0
-7	102	0	0
10	8	1	0
-12	203	25	0
0	12	3	0
-18	305	76	0
-10	14	4	1
-23	356	102	25
-20	14	6	3
-29	356	152	76
-30	16	8	4
-34	406	203	102
-40	18	8	4
-40	457	203	102
-50	20	10	6
-46	508	254	152
-60	20	10	6
-51	508	254	152

**NOTE:** Exposed minimum barrel lengths are inclusive up to 30-mph/48-kph wind velocities

## WARRANTY

Refer to the Warranty section of the current Price List or contact Victaulic for details.

For complete contact information, visit [www.victaulic.com](http://www.victaulic.com)

40.69 5660 REV C UPDATED 08/2010

VICTAULIC IS A REGISTERED TRADEMARK OF VICTAULIC COMPANY. © 2010 VICTAULIC COMPANY. ALL RIGHTS RESERVED.

