

Victaulic® Open Spray Nozzles

Style V12



Nozzles are shown in the upright position for clarity
may be installed in any position to meet design requirements.
K5.6 versions shown.

1.0 PRODUCT DESCRIPTION

Minimum Operating Pressure

- Pendant Position (vertically downward) 10 psi/0.7 bar. All other positions 20 psi/1.4 bar

Maximum Operating Pressure

- 175 psi/12 bar

Thread size

- ½"/15 mm NPT

NOTE

- Orifice sizes are indicated by the K-Factor, which is marked on the deflector. Refer to the Nominal Discharge Curves on pages 5 and 7 for each nozzle at various operating residual pressures.

Overall Length

- 2 7/16"/61 mm

ALWAYS REFER TO ANY NOTIFICATIONS AT THE END OF THIS DOCUMENT REGARDING PRODUCT INSTALLATION, MAINTENANCE OR SUPPORT.

System No.		Location	
Submitted By		Date	

Spec Section		Paragraph	
Approved		Date	

1.0 PRODUCT DESCRIPTION (Continued)

Model Numbers

Nominal K-Factor	Available Deflector Angles							
	1.2 (1.7 metric)	V1201 (180°)	V1202 (160°)	V1203 (140°)	V1204 (125°)	V1205 (110°)	V1206 (95°)	V1207 (80°)
1.8 (2.6 metric)	V1211 (180°)	V1212 (160°)	V1213 (140°)	V1214 (125°)	V1215 (110°)	V1216 (95°)	V1217 (80°)	V1218 (65°)
2.3 (3.3 metric)	V1221 (180°)	V1222 (160°)	V1223 (140°)	V1224 (125°)	V1225 (110°)	V1226 (95°)	V1227 (80°)	V1228 (65°)
3.2 (4.6 metric)	V1231 (180°)	V1232 (160°)	V1233 (140°)	V1234 (125°)	V1235 (110°)	V1236 (95°)	V1237 (80°)	V1238 (65°)
4.1 (5.9 metric)	V1241 (180°)	V1242 (160°)	V1243 (140°)	V1244 (125°)	V1245 (110°)	V1246 (95°)	V1247 (80°)	V1248 (65°)
4.9 (7.1 metric)	V1251 (180°)	V1252 (160°)	V1253 (140°)	V1254 (125°)	V1255 (110°)	V1256 (95°)	V1257 (80°)	V1258 (65°)
5.6 (8.1 metric)	V1261 (180°)	V1262 (160°)	V1263 (140°)	V1264 (125°)	V1265 (110°)	V1266 (95°)	V1267 (80°)	V1268 (65°)
7.2 (10.4 metric ¹)	V1271 (180°)	V1272 (160°)	V1273 (140°)	V1274 (125°)	V1275 (110°)	V1276 (95°)	V1277 (80°)	V1278 (65°)

¹ Metric K-Factor measurement shown is when pressure is measured in kPa. When pressure is measured in Bar, multiply the metric K-Factor shown by 10.0.

NOTES

- Victaulic V12 Spray Nozzles are open type spray nozzles designed for directional spray applications in fixed fire protection systems. They have an open design only (non-automatic) with a deflector that discharges a solid uniform cone spray of low- to medium- velocity water droplets. Victaulic V12 Spray Nozzles are available in multiple orifice sizes and spray angles to meet various design application requirements.
- For For nozzles having nominal U.S. K-Factors of 1.2, 1.8, 2.3, and 3.2, a bushing is used, whereas nozzles with K-Factors of 4.1, 4.9, 5.6, and 7.2 are machined orifices.

2.0 CERTIFICATION/LISTINGS



NOTE

- Refer to Victaulic [submittal publication 10.01](#) for details.

3.0 SPECIFICATIONS – MATERIAL

Frame Casting: Dezincification resistant die cast brass.

Splitter: Brass UNS-C36000.

Bushing (for nozzles with 1.2, 1.8, 2.3, and 3.2 K-Factors): Brass UNS-C36000

Deflector: Brass UNS-C51000

Screw: Stainless Steel UNS-S30400

Accessories:

Sprinkler Wrenches:

A. Standard Wrench: V27 Open End

Finishes: (specify choice)

Plain Brass.

VC-250².

² UL Listed and FM Approved for corrosion resistance.

4.0 DIMENSIONS

Style V12

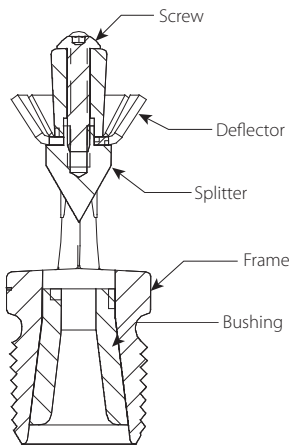
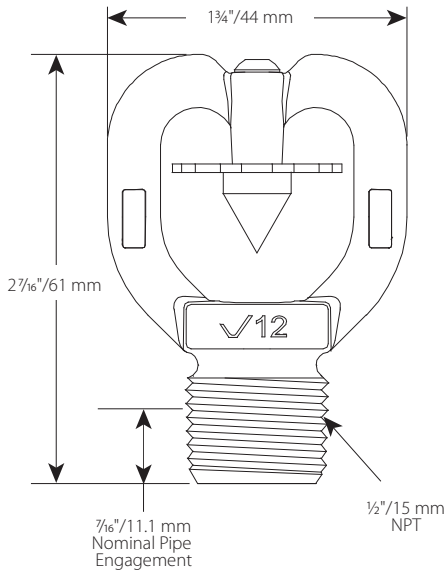

5.0 PERFORMANCE - INSTALLATION TECHNICAL DATA

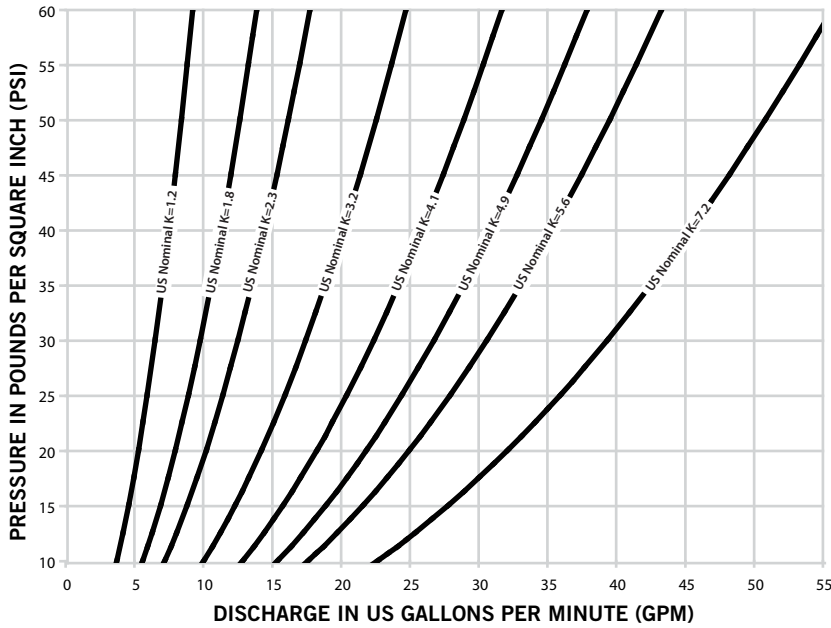

Figure 1 - K Factor Discharge Curves

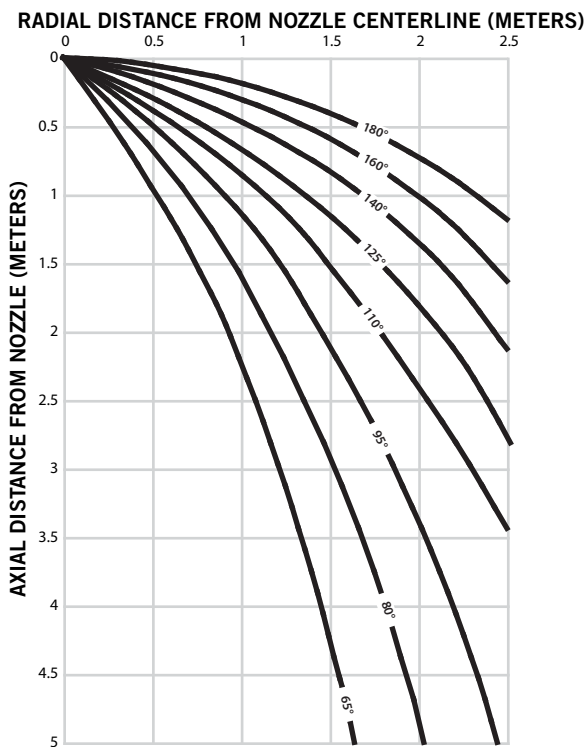

Figure 2 - Design Spray Profiles (All K Factors)

NOTES

- K-factors have tolerances of +/- 0.2 GPM/ $\sqrt{\text{PSI}}$ (0.2 LPM/ $\sqrt{\text{kPa}}$) from nominal. The design spray profile is the included angle of discharge for each nozzle.
- Figure 2 illustrates the radial distance at various heights based upon testing in the pendent position at 10 psi, 20 psi, and 60 psi / 69 kPa, 138 kPa, and 414 kPa discharge pressure (see Figure 3, Variable C).
- For FM only installations, use a recommended tolerance of +/- 2 ft [0.6 m] from nominal for the radial distances shown (x-axis) in Figure 2 for all fixed angle orientations. Use a recommended spray profile angle tolerance of +/- 5° in the pendent position (vertically downward) and +/- 10° in all other fixed angle orientations.
- For UL/NFPA only installations, use a recommended tolerance of +/- 15% from nominal for the radial distances shown (x-axis) in Figure 2 for all fixed angle orientations.
- Spray profiles will tend to decrease (or pull inward) with an increase in pressure. All test data was obtained in a stagnant air environment.
- See Exposure Protection Tables for fixed angle orientation and maximum axial distance from the plane of protection for each model.

5.0 PERFORMANCE - INSTALLATION TECHNICAL DATA

Exposure Protection Tables (Imperial)

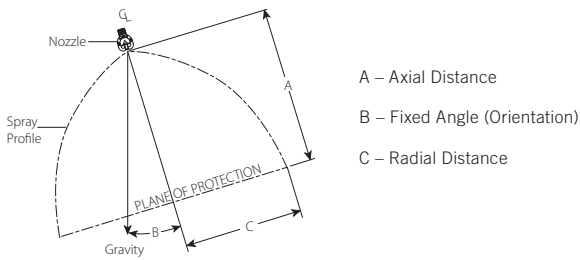

Figure 3 - Spray Coverage Variables

Maximum Axial Distance For 65° Spray Angle In Feet And Inches									
Fixed Angle	K Factor								
	1.2	1.8	2.3	3.2	4.1	4.9	5.6	7.2	
0°	14-9	15-0	15-0	15-3	15-3	15-6	15-9	16-0	
30°	9-9	9-9	10-0	10-3	10-6	10-9	11-0	11-6	
45°	8-0	8-0	8-6	9-0	9-3	9-6	9-9	10-3	
60°	7-0	7-3	7-9	8-3	8-6	8-6	8-9	9-6	
90°	6-6	6-9	7-0	7-6	7-9	8-0	8-0	8-6	
120°	6-3	6-6	6-9	7-3	7-3	7-6	7-6	7-9	
135°	5-9	6-0	6-3	6-6	6-9	6-9	7-0	7-6	
150°	5-6	5-9	6-0	6-0	6-6	6-9	6-9	7-3	
180°	5-0	5-0	5-3	5-6	6-0	6-3	6-6	6-9	

Maximum Axial Distance For 125° Spray Angle In Feet And Inches									
Fixed Angle	K Factor								
	1.2	1.8	2.3	3.2	4.1	4.9	5.6	7.2	
0°	7-9	7-9	7-9	8-0	8-3	8-3	8-6	8-9	
30°	5-0	5-3	5-6	5-9	6-9	7-3	7-9	7-9	
45°	4-3	4-6	4-9	5-0	6-0	6-3	6-6	7-0	
60°	3-6	3-9	4-0	4-3	5-3	5-6	5-9	6-3	
90°	3-0	3-3	3-6	3-6	4-3	4-6	4-9	5-3	
120°	2-0	2-0	2-6	3-3	3-9	3-9	3-9	4-3	
135°	1-9	1-9	2-3	3-0	3-6	3-6	3-6	3-9	
150°	1-6	1-9	2-3	2-6	3-0	3-3	3-3	3-6	
180°	1-3	1-6	2-0	2-6	2-9	2-9	3-0	3-3	

Maximum Axial Distance For 80° Spray Angle In Feet And Inches									
Fixed Angle	K Factor								
	1.2	1.8	2.3	3.2	4.1	4.9	5.6	7.2	
0°	14-9	15-0	15-0	15-3	15-3	15-6	15-9	16-0	
30°	9-6	9-9	10-3	10-6	10-9	10-9	11-0	11-3	
45°	7-6	7-9	8-3	8-6	8-9	9-0	9-3	9-9	
60°	6-3	6-6	6-9	7-0	7-3	7-6	8-3	8-9	
90°	5-9	6-3	6-6	6-9	7-0	7-3	7-6	7-9	
120°	5-3	5-6	5-9	6-0	6-3	6-3	6-6	7-0	
135°	4-9	5-3	5-6	5-9	6-0	6-0	6-3	6-6	
150°	4-3	4-6	4-9	5-6	5-9	5-9	6-0	6-0	
180°	4-0	4-3	4-6	5-3	5-6	5-6	5-9	5-9	

Maximum Axial Distance For 140° Spray Angle In Feet And Inches									
Fixed Angle	K Factor								
	1.2	1.8	2.3	3.2	4.1	4.9	5.6	7.2	
0°	6-3	6-3	6-3	6-6	6-6	6-6	6-9	6-9	
30°	3-9	3-9	4-3	4-9	5-3	5-3	5-6	5-9	
45°	3-0	3-3	3-6	4-3	4-9	5-0	5-0	5-3	
60°	2-3	2-6	2-9	3-9	4-3	4-3	4-6	4-9	
90°	2-0	2-0	2-6	3-0	3-6	3-9	3-9	4-0	
120°	1-9	1-9	2-3	2-6	2-9	2-9	3-0	3-6	
135°	1-6	1-6	1-9	2-3	2-6	2-6	2-9	3-0	
150°	1-3	1-3	1-6	1-9	2-0	2-0	2-3	2-6	
180°	1-0	1-0	1-3	1-6	1-9	1-9	2-0	2-3	

Maximum Axial Distance For 95° Spray Angle In Feet And Inches									
Fixed Angle	K Factor								
	1.2	1.8	2.3	3.2	4.1	4.9	5.6	7.2	
0°	14-9	15-0	15-0	15-3	15-3	15-6	15-9	16-0	
30°	8-3	8-6	9-3	9-6	10-3	10-6	10-6	11-3	
45°	7-0	7-0	7-3	7-6	8-6	8-9	9-0	9-9	
60°	5-3	5-6	5-9	6-6	6-9	7-0	7-6	8-6	
90°	4-6	4-9	5-6	5-9	6-0	6-0	6-3	6-9	
120°	4-0	4-3	4-6	5-0	5-3	5-6	5-6	5-9	
135°	3-9	3-9	4-3	4-9	5-0	5-3	5-3	5-6	
150°	3-3	3-6	3-6	4-6	4-9	4-9	5-0	5-3	
180°	3-0	3-3	3-3	4-0	4-3	4-3	4-6	4-9	

Maximum Axial Distance For 160° Spray Angle In Feet And Inches									
Fixed Angle	K Factor								
	1.2	1.8	2.3	3.2	4.1	4.9	5.6	7.2	
0°	4-9	4-9	4-9	5	5	5	5-3	5-3	
30°	3-9	3-9	4-0	4-0	4-6	4-6	4-6	4-9	
45°	3-0	3-0	3-6	3-9	4-0	4-0	4-0	4-3	
60°	2-0	2-0	2-3	2-6	3-3	3-3	3-6	3-6	
90°	1-0	1-3	1-9	2-0	2-6	2-6	2-6	2-9	
120°	NR	1-0	1-6	1-9	2-0	2-3	2-3	2-6	
135°	NR	NR	1-0	1-6	1-9	1-9	1-9	2-0	
150°	NR	NR	NR	1-0	1-3	1-3	1-6	1-9	
180°	NR	NR	NR	1-0	1-0	1-0	1-3	1-6	

Maximum Axial Distance For 110° Spray Angle In Feet And Inches									
Fixed Angle	K Factor								
	1.2	1.8	2.3	3.2	4.1	4.9	5.6	7.2	
0°	9-6	9-9	9-9	10-0	10-3	10-6	10-9	11-0	
30°	6-6	6-9	7-3	8-0	8-6	8-9	9-0	9-6	
45°	5-6	6-0	6-9	7-0	7-6	7-9	8-3	8-6	
60°	4-9	5-0	5-6	5-9	6-3	6-9	7-3	7-9	
90°	3-9	4-0	4-6	4-9	5-3	5-6	5-9	6-3	
120°	3-3	3-6	4-0	4-3	4-6	4-6	4-9	5-3	
135°	2-9	3-0	3-6	4-0	4-3	4-3	4-6	4-9	
150°	2-6	2-9	3-3	3-6	4-0	4-3	4-3	4-6	
180°	2-3	2-6	3-0	3-3	3-6	3-9	4-0	4-3	

Maximum Axial Distance For 180° Spray Angle In Feet And Inches									
Fixed Angle	K Factor								
	1.2	1.8	2.3	3.2	4.1	4.9	5.6	7.2	
0°	3-3	3-3	3-3	3-6	3-6	3-9	3-9	3-9	
30°	2-3	2-3	2-6	2-9	3-0	3-3	3-3	3-3	
45°	2-0	2-0	2-3	2-6	2-9	3-0	3-0	3-0	
60°	1-6	1-6	1-9	2-0	2-3	2-3	2-6	2-6	
90°	NR	NR	1-0	1-0	1-6	1-9	2-0	2-3	
120°	NR	NR	1-0	1-0	1-3	1-6	1-6	1-9	
135°	NR	NR	NR	1-0	1-0	1-3	1-3	1-6	
150°	NR	NR	NR	NR	1-0	1-0	1-3	1-3	
180°	NR	NR	NR	NR	NR	1-0	1-0	1-0	

5.0 PERFORMANCE - INSTALLATION TECHNICAL DATA

Figure 4 - K Factor Discharge Curves (Metric)

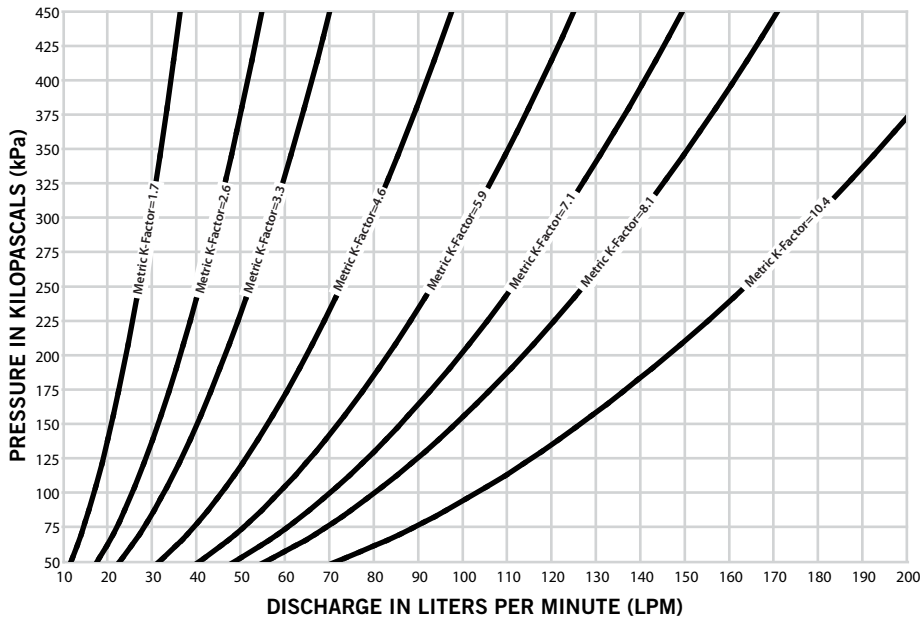
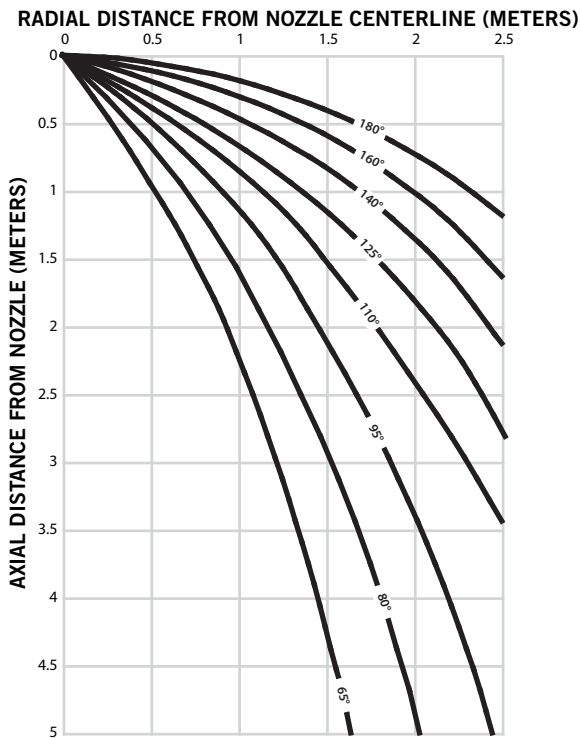

Figure 5 - Design Spray Profiles (Metric, All K Factors)



NOTES

- K-factors have tolerances of +/- 0.2 GPM/ $\sqrt{\text{PSI}}$ (0.2 LPM/ $\sqrt{\text{kPA}}$) from nominal. The design spray profile is the included angle of discharge for each nozzle.
- Figure 5 illustrates the radial distance at various heights based upon testing in the pendent position at 10 psi, 20 psi, and 60 psi / 69 kPa, 138 kPa, and 414 kPa discharge pressure (see Figure 3, Variable C).
- For FM only installations, use a recommended tolerance of +/- 2 ft [0.6 m] from nominal for the radial distances shown (x-axis) in Figure 2 for all fixed angle orientations. Use a recommended spray profile angle tolerance of +/- 5° in the pendent position (vertically downward) and +/- 10° in all other fixed angle orientations.
- For UL/NFPA only installations, use a recommended tolerance of +/- 15% from nominal for the radial distances shown (x-axis) in Figure 2 for all fixed angle orientations.
- Spray profiles will tend to decrease (or pull inward) with an increase in pressure. All test data was obtained in a stagnant air environment.
- See Exposure Protection Tables for fixed angle orientation and maximum axial distance from the plane of protection for each model.
- See Exposure Protection Tables for fixed angle orientation and maximum axial distance from the plane of protection for each model.

5.0 PERFORMANCE - INSTALLATION TECHNICAL DATA

Exposure Protection Tables (Metric)

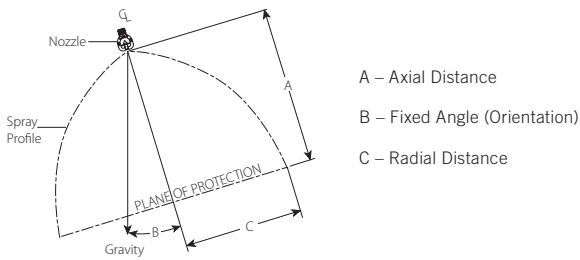

Figure 6 - Spray Coverage Variables

Maximum Axial Distance For 65° Spray Angle In Meters									
Fixed Angle	K Factor								
	1.7	2.6	3.3	4.6	5.9	7.1	8.1	10.4	
0°	4.5	4.6	4.6	4.6	4.6	4.7	4.8	4.9	
30°	3.0	3.0	3.0	3.1	3.2	3.4	3.4	3.5	
45°	2.4	2.4	2.6	2.7	2.8	3.0	3.0	3.1	
60°	2.1	2.2	2.4	2.5	2.6	2.7	2.7	2.9	
90°	2.0	2.1	2.1	2.3	2.4	2.4	2.4	2.6	
120°	1.9	2.0	2.1	2.2	2.2	2.3	2.3	2.4	
135°	1.8	1.8	1.9	2.0	2.1	2.1	2.1	2.3	
150°	1.7	1.8	1.8	1.8	2.0	2.1	2.1	2.2	
180°	1.5	1.5	1.6	1.7	1.8	2.0	2.0	2.1	

Maximum Axial Distance For 125° Spray Angle In Meters									
Fixed Angle	K Factor								
	1.7	2.6	3.3	4.6	5.9	7.1	8.1	10.4	
0°	2.4	2.4	2.4	2.4	2.5	2.5	2.6	2.7	
30°	1.5	1.6	1.7	1.8	2.1	2.2	2.4	2.4	
45°	1.3	1.4	1.4	1.5	1.8	1.9	2.0	2.1	
60°	1.1	1.1	1.2	1.3	1.6	1.7	1.8	1.9	
90°	0.9	1.0	1.1	1.1	1.3	1.4	1.4	1.6	
120°	0.6	0.6	0.8	1.0	1.1	1.1	1.1	1.3	
135°	0.5	0.5	0.7	0.9	1.1	1.1	1.1	1.1	
150°	0.5	0.5	0.7	0.8	0.9	1.0	1.0	1.1	
180°	0.4	0.5	0.6	0.8	0.8	0.8	0.9	1.0	

Maximum Axial Distance For 80° Spray Angle In Meters									
Fixed Angle	K Factor								
	1.7	2.6	3.3	4.6	5.9	7.1	8.1	10.4	
0°	4.5	4.6	4.6	4.6	4.6	4.8	4.8	4.9	
30°	2.9	3.0	3.1	3.2	3.3	3.3	3.4	3.4	
45°	2.3	2.4	2.5	2.6	2.7	2.7	2.8	3.0	
60°	1.9	2.0	2.1	2.1	2.2	2.3	2.5	2.7	
90°	1.8	1.9	2.0	2.1	2.1	2.2	2.3	2.4	
120°	1.6	1.7	1.8	1.8	1.9	1.9	2.0	2.1	
135°	1.4	1.6	1.7	1.8	1.8	1.8	1.9	2.0	
150°	1.3	1.4	1.4	1.7	1.8	1.8	1.8	1.8	
180°	1.2	1.3	1.4	1.6	1.7	1.7	1.8	1.8	

Maximum Axial Distance For 140° Spray Angle In Meters									
Fixed Angle	K Factor								
	1.7	2.6	3.3	4.6	5.9	7.1	8.1	10.4	
0°	1.9	1.9	1.9	2.0	2.0	2.0	2.1	2.1	
30°	1.1	1.1	1.3	1.4	1.6	1.6	1.7	1.8	
45°	0.9	1.0	1.1	1.3	1.4	1.5	1.5	1.6	
60°	0.7	0.8	0.8	1.1	1.3	1.3	1.4	1.4	
90°	0.6	0.6	0.8	0.9	1.1	1.1	1.1	1.2	
120°	0.5	0.5	0.7	0.8	0.8	0.8	0.9	1.1	
135°	0.5	0.5	0.5	0.7	0.8	0.8	0.8	0.9	
150°	0.4	0.4	0.5	0.5	0.6	0.6	0.7	0.8	
180°	0.3	0.3	0.4	0.5	0.5	0.5	0.6	0.7	

Maximum Axial Distance For 95° Spray Angle In Meters									
Fixed Angle	K Factor								
	1.7	2.6	3.3	4.6	5.9	7.1	8.1	10.4	
0°	4.5	4.6	4.6	4.6	4.6	4.7	4.8	4.9	
30°	2.5	2.6	2.8	2.9	3.1	3.2	3.2	3.4	
45°	2.1	2.1	2.2	2.3	2.6	2.7	2.7	3.0	
60°	1.6	1.7	1.8	2.0	2.1	2.1	2.3	2.6	
90°	1.4	1.4	1.7	1.8	1.8	1.8	1.9	2.1	
120°	1.2	1.3	1.4	1.5	1.6	1.7	1.7	1.8	
135°	1.1	1.1	1.3	1.4	1.5	1.6	1.6	1.7	
150°	1.0	1.1	1.1	1.4	1.4	1.4	1.5	1.6	
180°	0.9	1.0	1.0	1.2	1.3	1.3	1.4	1.4	

Maximum Axial Distance For 160° Spray Angle In Meters									
Fixed Angle	K Factor								
	1.7	2.6	3.3	4.6	5.9	7.1	8.1	10.4	
0°	1.4	1.4	1.4	1.5	1.5	1.5	1.6	1.6	
30°	1.1	1.1	1.2	1.2	1.4	1.4	1.4	1.4	
45°	0.9	0.9	1.1	1.1	1.2	1.2	1.2	1.3	
60°	0.6	0.6	0.7	0.8	1.0	1.0	1.1	1.1	
90°	0.3	0.4	0.5	0.6	0.8	0.8	0.8	0.8	
120°	NR	0.3	0.5	0.5	0.6	0.7	0.7	0.8	
135°	NR	NR	0.3	0.5	0.5	0.5	0.5	0.6	
150°	NR	NR	NR	0.3	0.4	0.4	0.5	0.5	
180°	NR	NR	NR	0.3	0.3	0.3	0.4	0.5	

Maximum Axial Distance For 110° Spray Angle In Meters									
Fixed Angle	K Factor								
	1.7	2.6	3.3	4.6	5.9	7.1	8.1	10.4	
0°	2.9	3.0	3.0	3.0	3.0	3.2	3.3	3.4	
30°	2.0	2.1	2.2	2.4	2.6	2.7	2.7	2.9	
45°	1.7	1.8	2.1	2.1	2.3	2.4	2.5	2.6	
60°	1.4	1.5	1.7	1.8	1.9	2.1	2.2	2.4	
90°	1.1	1.2	1.4	1.4	1.6	1.7	1.8	1.9	
120°	1.0	1.1	1.2	1.3	1.4	1.4	1.4	1.6	
135°	0.8	0.9	1.1	1.2	1.3	1.3	1.4	1.4	
150°	0.8	0.8	1.0	1.1	1.2	1.3	1.3	1.4	
180°	0.7	0.8	0.9	1.0	1.1	1.1	1.2	1.3	

Maximum Axial Distance For 180° Spray Angle In Meters									
Fixed Angle	K Factor								
	1.7	2.6	3.3	4.6	5.9	7.1	8.1	10.4	
0°	1.0	1.0	1.0	1.1	1.1	1.1	1.1	1.1	
30°	0.7	0.7	0.8	0.8	0.9	1.0	1.0	1.0	
45°	0.6	0.6	0.7	0.8	0.8	0.9	0.9	0.9	
60°	0.5	0.5	0.5	0.6	0.7	0.7	0.8	0.8	
90°	NR	NR	0.3	0.3	0.5	0.5	0.5	0.7	
120°	NR	NR	0.3	0.3	0.4	0.5	0.5	0.5	
135°	NR	NR	NR	0.3	0.3	0.4	0.4	0.5	
150°	NR	NR	NR	NR	0.3	0.3	0.4	0.4	
180°	NR	NR	NR	NR	NR	0.3	0.3	0.3	

6.0 NOTIFICATIONS

WARNING

- Victaulic V12 Spray Nozzles are manufactured and tested to meet the rigid requirements of the approving agency.
- The nozzles are designed to be installed in accordance with recognized installation standards. Deviation from the standards or any alteration to the nozzle after it leaves the factory including, but not limited to: painting, plating, coating, or modification, may render the unit inoperative and will automatically nullify the approval and any guarantee made by Victaulic.

The Approval Chart shows listings and approvals of Victaulic V12 Spray Nozzles for use on water spray systems and water based deluge systems. The chart shows listings and approvals available at the time of printing. Other approvals may be in process.

Check with the manufacturer for any additional approvals.

7.0 REFERENCE MATERIALS

Ordering Information:

Please specify the following when ordering:

- Sprinkler Model Number
- K Factor
- Spray Angle
- Nozzle Finish
- Wrench Model Number

Installation:

- A. Victaulic V12 Spray nozzles are to be installed in accordance with the latest edition A. of Victaulic technical data, the latest published standards of NFPA or other similar organizations, and also with the provisions of governmental codes, ordinances, and standards whenever applicable. The use of Victaulic V12 Spray Nozzles may be limited due to occupancy and hazard. Refer to the Authority Having Jurisdiction prior to installation.
- B. Spray nozzles are installed on fixed fire protection systems, such as deluge systems, where totalflooding is required.
- C. See Victaulic publication I-40 for installation and maintenance instructions.
- D. Spray nozzles must be inspected on a regular basis for corrosion, mechanical damage, obstructions, paint, etc. Where open spray nozzles are installed, verify that foreign materials (such as dust, dirt, etc.) do not restrict or plug the water spray. The frequency of inspections may vary due to corrosive atmospheres, water supplies, and activity around the device.

NOTE

- A system strainer is needed if orifice diameter is less than $\frac{3}{8}$ "/9.4 mm, which includes V12 spray nozzles of K-Factors 3.2, 2.3, 1.8 and 1.2.

User Responsibility for Product Selection and Suitability

Each user bears final responsibility for making a determination as to the suitability of Victaulic products for a particular end-use application, in accordance with industry standards and project specifications, and the applicable building codes and related regulations as well as Victaulic performance, maintenance, safety, and warning instructions. Nothing in this or any other document, nor any verbal recommendation, advice, or opinion from any Victaulic employee, shall be deemed to alter, vary, supersede, or waive any provision of Victaulic Company's standard conditions of sale, installation guide, or this disclaimer.

Intellectual Property Rights

No statement contained herein concerning a possible or suggested use of any material, product, service, or design is intended, or should be construed, to grant any license under any patent or other intellectual property right of Victaulic or any of its subsidiaries or affiliates covering such use or design, or as a recommendation for the use of such material, product, service, or design in the infringement of any patent or other intellectual property right. The terms "Patented" or "Patent Pending" refer to design or utility patents or patent applications for articles and/or methods of use in the United States and/or other countries.

Note

This product shall be manufactured by Victaulic or to Victaulic specifications. All products to be installed in accordance with current Victaulic installation/assembly instructions. Victaulic reserves the right to change product specifications, designs and standard equipment without notice and without incurring obligations.

Installation

Reference should always be made to the Victaulic installation handbook or installation instructions of the product you are installing. Handbooks are included with each shipment of Victaulic products, providing complete installation and assembly data, and are available in PDF format on our website at www.victaulic.com.

Warranty

Refer to the Warranty section of the current Price List or contact Victaulic for details.

Trademarks

Victaulic and all other Victaulic marks are the trademarks or registered trademarks of Victaulic Company, and/or its affiliated entities, in the U.S. and/or other countries.